

# Guidelines

## Energy Efficiency in Water and Wastewater Utilities



November 2015 (2<sup>nd</sup> Edition)



# **Energy Efficiency in Water and Wastewater Utilities**

Developed under the guidance of the  
ACWUA Energy Efficiency Task Force  
with support from GIZ ACWUA WANT programme 2013-2015

## **Guidelines**

### **Energy Efficiency for Water and Wastewater Utilities**

#### **Published by**

The Arab Countries Water Utilities Association (ACWUA)  
under the guidance of the ACWUA Task Force Energy Efficiency  
with support from the Deutsche Gesellschaft für Internationale Zusammenarbeit (GIZ) GmbH

#### **Registered offices**

ACWUA in Amman, Jordan  
GIZ in Bonn and Eschborn, Germany

#### **Implemented by**

Strengthening the MENA water sector through regional networking and training (**ACWUA WANT**) programme  
[www.mena-water.net](http://www.mena-water.net) or [www.acwua.org/training](http://www.acwua.org/training) or [www.acwua.org/node/413](http://www.acwua.org/node/413)

#### **Arab Countries Water Utilities Association (ACWUA)**

19A, Umm Umarah Street. Al-Rashed Area  
P.O.Box 962449 Amman  
11196 Jordan

and

#### **Deutsche Gesellschaft für Internationale Zusammenarbeit (GIZ) GmbH**

65760 Eschborn, Germany  
Dag-Hammarskjöld-Weg 1-5  
Division 3300 Near East

#### **On behalf of the**

German Federal Ministry for Economic Cooperation and Development (BMZ)

#### **Authors (revised 2nd edition)**

CONSULAQUA Hamburg Beratungsgesellschaft mbH  
Lucatina Ercolano (Consulaqua) and Holger Laenge (Hamburg Wasser)  
iat Darmstadt

Bernd Haberkern (responsible for wastewater component)

with kind permission from the German Water Association: DWA Deutsche Vereinigung für Wasserwirtschaft, Abwasser und Abfall e.V.: Arbeitsblatt DWA-A 216. Energiechecks und Energieanalyse – Instrumente zur Energieoptimierung von Abwasseranlagen, Dezember 2015 (in German only)

Peer reviewers:

Jan Uwe Lieback, Hans Hartung, Bernd Haberkern; Cornelius de Jong

#### **Authors of the 1st edition November 2014**

Tuttahs & Meyer Ingenieurgesellschaft für Wasser, Abwasser und Energiewirtschaft mbH, Aachen  
Main authors: Eric Gramlich and Markus Schröder

#### **Programme supervision**

Thomas Petermann (GIZ Germany)  
Abdellatif Biad (ONEE, Morocco. Chairperson ACWUA Task Force Energy Efficiency)  
Mustafa Nasereddin (ACWUA Jordan)

#### **Photo credits**

Thomas Petermann

#### **Disclaimer**

The material in this publication was written by, and reflects the views of the authors. None of the material implies an opinion of any form by GIZ or ACWUA. The information in this book is distributed on an "As is" basis, without warranty.

Copyright November 2015 ACWUA and GIZ

# Preface

## Energy Efficiency – A strategic objective and assigned target of ACWUA

In most cases energy is the number one cost within all water and wastewater service utilities O&M costs, and a controllable one at that. In addition, it has been reported that the potential for energy savings at utilities in the developing world can reach between 30-40%, depending on the baseline situation, and that many energy efficiency (EE) measures have a payback period of less than five years (Feng Liu et al, 2012). This means that investing in energy efficiency would enable the utility to expand and/or improve its services because of the gains achieved.

Financial benefits may be the number one priority for any utility when considering system improvements, but reducing energy consumption not only reduces costs and operating expenditures; it also has a direct impact on reducing Green House Gas (GHG) emissions, and reducing the pressure of adding or sustaining power generation capacity on the national level. Consequently, improving EE in WWS utilities is the right way to save money, extend the life of existing infrastructure, and contribute to environmental sustainability.

There is no one-size-fits-all EE indicator in the WWS industry, as each utility is unique in terms of the types of processes and technology it applies; which water resources it utilizes, the size of the communities it serves, how they are dispersed, applicable standards and regulatory requirements, as well as the availability and price of energy sources. Each utility needs to evaluate its own goals, financial situation and commitment to improving EE.

In July 2014, ACWUA issued a Best Practices Guide on utilities management listing the main pillars for managing water utilities: 1. Cost Recovery; 2. Non-revenue Water Management; 3. Asset Management; 4. Serving the Poor; 5. Energy Efficiency. The Energy Efficiency section addressed the importance of enabling an environment for applying energy efficiency, the types of energy efficiency programs, and technical aspects for those programs. That was the start for tackling energy management issues with guiding principles for water utilities within ACWUA membership.

Today the **Guidelines on Energy Efficiency** and the associated **Reader of Good Practices from ACWUA members** present a detailed and thorough review of current energy consumption patterns at water and wastewater utilities in the Arab region. The documents are based on field visits and analysis of different pilot sites within ACWUA membership. The exclusivity of the guideline comes from its development process, with the support of GIZ regional capacity development program (ACWUA WANT) and the voluntary work of ACWUA Energy Efficiency Task Force. It reflects the current situation and what should be done at the operational level to implement energy efficiency measures and aim to reduce energy consumption at even higher levels.

Today ACWUA membership comprises 108 utilities from 18 Arab countries. ACWUA is very proud of the energy efficiency program outcomes and will advocate and share its findings with all members. With the support of GIZ and other international partners, ACWUA will work forward to scale-up a plan for the implementation of energy efficiency measures, improve financial performance and protect the environment.

Eng. Khaldon Khashman  
ACWUA Secretary General

Eng. Mustafa Nasereddin  
ACWUA Director of Program and Technical Services

# Foreword

We are pleased to present the 2nd edition of the revised Guidelines on Energy Efficiency (EE), developed under the guidance of the ACWUA Energy Efficiency Task Force with support from the GIZ ACWUA WANT programme. The guidelines aim to guide water and wastewater utilities in the MENA region to conduct systematic and comprehensive energy checks and analysis of their companies in order to optimize energy use, enhance energy efficiency, and reduce energy consumption. Finally, a module (Annex 2) assesses options for producing energy from hydroelectric power.

The authors are from the energy competence networks of the German Association for Water, Wastewater and Waste (DWA) and the German Technical and Scientific Association for Gas and Water (DVGW). These professional associations are responsible for setting standards and technical rules that are used for self-regulation and certification in the German water industry. They are partners of international associations and members of standardization organisations. By using the energy efficiency guidelines of German water associations and other international reference material, they ensure that the most up to date state-of-knowledge is applied.

These EE-Guidelines were developed over a period of almost 20 months. The 1st version was compiled in 2014 by Tuttahs & Meyer Ingenieurgesellschaft Aachen while the 2nd revised version was written in 2015 by Consulaqua, a subsidiary of Hamburg Wasser. While the 1st version of October 2014 focused towards the basic understanding and conceptual approach for energy checks, the 2nd revised Guidelines were authored by practitioners. They guide the user to apply energy checks and energy analysis with practical examples in pilot utilities, eventually directing them towards energy audits and complex energy management systems.

Both versions underwent several cycles of peer review during the period 2014-2015 with specialists from the German water sector and energy auditing experts. Members from the ACWUA EE-TF also had the opportunity at four workshops during 2014-2015 to review and comment; their demand for more practice-oriented guidelines and pilot tests has been taken into consideration for the TOR for the 2nd revised version. We are very grateful to the authors and to all experts from Germany and the MENA region who contributed to the reviews, and have applied numerous recommendations to finalize the 2<sup>nd</sup> edition in November 2015.

These EE-Guidelines were tested by three pilot utilities, SONEDE in Tunisia, ONEE in Morocco and Aqaba Water Company in Jordan. The energy checks and energy analysis at the water supply facilities were guided and supported by German experts from Hamburg Wasser, a company with longstanding experience in energy management - and known for its strategic target to be independent from external energy inputs before the year 2020.

Standards (e.g. ISO 50001) and Guidelines (Rules) are always more generic measures for providing a framework – and they are rarely aligned with actual operating procedures and workflows. These ACWUA EE Guidelines therefore try to bridge the gap between standards and site-specific operational rules. They may also be used to complement regulations for country-specific energy audits that consider the legal and policy frameworks in specific national contexts. It is expected that the EE Guidelines will provide practitioners with a step-by-step procedure to check, analyse and work constantly towards energy performance improvements in water and wastewater utilities. To be fit for the future will require qualified external energy auditors as well as committed staff in the water utilities, supported by energy policy at country level and coherent energy strategy at company level.

In a nutshell, the ACWUA WANT project assisted ACWUA and its Energy Efficiency Task Force in:

- developing ACWUA Guidelines on energy checks and energy analysis
- training energy experts from ACWUA utilities to apply the guidelines
- testing the guidelines in pilot utilities
- advocating energy efficiency and promoting the application of EE-Guidelines in the MENA region at ACWUA Best Practice Conferences, the Arab Water Week and other international forums
- increasing knowledge and sharing experiences on Energy Management Systems and Energy Audits in water and wastewater utilities.

*Abdellatif Biad, ONEE Morocco. Chair ACWUA EE-Task Force*

*Thomas Petermann, GIZ, ACWUA WANT project*

[www.mena-water.net/energy-efficiency](http://www.mena-water.net/energy-efficiency)





# Content

Preface.....	V
Foreword.....	VI
Content.....	IX
Figures and Tables.....	X
Abbreviations and Terms.....	XII
1. Background.....	1
2. Introduction.....	2
3. How to use this Guidance.....	6
4. Step 1 Administrative preparation.....	8
5. Step 2 System boundaries.....	9
6. Step 3 Energy Check.....	13
7. Step 4 Energy Analysis.....	33
8. Step 5 Energy Audit – the full view on all energy related aspects.....	51
9. Step 6 Energy Management - starting a continuous improvement cycle.....	56
10. Step 7 Financial Evaluation and Ranking.....	57
11. Step 8 Reporting and Documentation.....	62
12. References.....	64
13. Annexes.....	65
Module 1: Evaluation of Raw and Drinking Water Pumping Stations (Tunisia, Morocco)	
Module 2: Energy Recovery in ‘Hydroelectric Power Installations’ in Drinking Water Supply (Jordan)	

# Figures and Tables

- Figure 1: The ACWUA member countries in the MENA region (source: ACWUA 2015) .....1
- Figure 2: Case study Tunisia: Cost burden for water companies due to high energy costs.....2
- Figure 3: Reasons for EE operation (own graphic).....2
- Figure 4: Interrelation of the tools EC, EA, EAU and EnMS (own graphic).....4
- Figure 5: Overview of main steps of the EE guideline .....7
- Figure 6: Terminology and hierarchic structure of water supply systems.....9
- Figure 7: Graphic overview of the water production process steps of MEET KHMUS Plant in Egypt..... 10
- Figure 8: Energy consumption and options for energy generation in water supply systems..... 11
- Figure 9: Terminology and hierarchic structure of waste water systems (own graphic)..... 12
- Figure 10: Control level for pumps and PS (source: HAMBURG WASSER) ..... 14
- Figure 11: Recommended instrumentation for ECs (source: HAMBURG WASSER)..... 14
- Figure 12: Analogue pressure manometers (photos: CAH, 2015) ..... 15
- Figure 13: Pressure measurement using a portable electronic pressure sensor (Photo: CAH, 2015) ..... 15
- Figure 14: System parameters for ECs of PS ..... 15
- Figure 15: KPIs for PS..... 16
- Figure 16: Energy conversion through pumps (graphic from HAMBURG WASSER)..... 16
- Figure 17: Target efficiencies for pumps (source: HAMBURG WASSER ..... 17
- Figure 18: Case study Tunisia: Potential to increase the efficiency of pumps related to the nominal power ..... 18
- Figure 19: Exemplary KPI calculation ..... 19
- Figure 20: Frequency curve for specific power consumption for the entire WWTP  $e_{WWTP}$ ..... 28
- Figure 21: Frequency curve for the specific power consumption of aeration  $e_{aer}$ ..... 29
- Figure 22: Frequency curve for the specific production of biogas KPI  $y_{gas}$ ..... 29
- Figure 23: Frequency curve for electrical self-sufficiency in WWTPs..... 30
- Figure 24: Process for the EA, exemplary for PS (pump stations) ..... 33
- Figure 25: Typical LCC of a pump (source: WILO 2014) ..... 35
- Figure 26: Example of measurement results from an EC to be used for derivation of a system curve for pumping station Ciceron in St. Lucia, Caribbean (2015) (source: CAH)..... 36
- Figure 27: System curve for measurement results as shown in Figure 26 (CAH, 2015)..... 36
- Figure 28: System curve (exemplarily) (source: HW 2015) ..... 37
- Figure 29: Determination of operating point (source: HW 2015) ..... 37
- Figure 30: Best efficiency point (BEP) (source: HW 2015) ..... 38
- Figure 31: Description of operation areas for pumps (own graphic) ..... 38
- Figure 32: Operation areas of a pump (source: HW 2015)..... 39
- Figure 33: Failures at different pump areas (source: Barringer, 1999) ..... 39
- Figure 34: Initial measures to improve pump operation ..... 40
- Figure 35: Visualization of 'bad' system curves (source: HW, 2015)..... 41

Figure 36: Measures to enhance the EE of pumps and stations (developed by EE-TF members in 2015) .....	41
Figure 37: Newly painted pump casing (photo: Morocco, 2015) .....	42
Figure 38: The pump life cycle management (graphic: HW, 2015).....	42
Figure 39: The stages in a WWTP energy analysis.....	44
Figure 40: Extract from the list of electromechanical equipment for a WWTP in Tunisia (Djerba Aghir).....	46
Figure 41: Breakdown of power consumption for a WWTP in Tunisia (Djerba Aghir).....	46
Figure 42: Actual and theoretical power consumption .....	47
Figure 43: Energy usage figures with optimisation measures .....	49
Figure 44: Elements of the EAU acc. to Lieback, 2015 .....	51
Figure 45: Pump live cycle management (graphic. HW, 2015).....	52
Figure 46: PLCM steps and usual performance patterns of utilities (source: HW, 2015).....	53
Figure 47: Examples of energy influencing factors (source: HW, 2015) .....	55
Figure 48: Investment Costs of the Rated Power (1 Jordan Dinar = 1,14238 €) (source, HW project in Jordan, 2001) .....	59
Figure 49: Cost benefit analyses Daourate TW PS (2015) .....	60
Figure 50: Financial evaluation Break Even Point Daourate TW PS (2015) .....	61
Table 1: Administrative requirements before starting an EE improvement process.....	8
Table 2: Conversion of energy units (source: HAMBURG WASSER).....	21
Table 3: Unit conversion for KPIs in WWTPs.....	23
Table 4: Key performance indicators for WWTPs .....	25
Table 5: Key performance indicators for cogeneration modules.....	30
Table 6: Total output for wastewater and treatment sludge pumps .....	31
Formula 1: KPI 1: Overall efficiency.....	17
Formula 2: KPI 2: Specific energy consumption [Wh/m <sup>3</sup> /m].....	17
Formula 3: KPI 3: Specific energy consumption [kWh/m <sup>3</sup> ].....	18

## Abbreviations and Terms

ACWUA	Arab Countries Water Utilities Association
ACWUA WANT	Strengthening the MENA Water Sector through Regional Networking and Training. A GIZ capacity development project, implemented with ACWUA
AW	Aqaba Water Company, Jordan
CAH	Consulaqua Hamburg
DWA	German Water Association (Deutsche Vereinigung für Wasserwirtschaft, Abwasser und Abfall)
EA	Energy Analysis
EAU	Energy Audit
EC	Energy Check
EE	Energy Efficiency
EE-TF	Energy Efficiency Task Force, established in Dec 2013 in Algiers
EI	Electric
EnMS	Energy Management System
GIZ	Deutsche Gesellschaft für Internationale Zusammenarbeit GmbH, Germany
GL	Guidelines
h	Hour
H	Head loss / Pressure head
HW	HAMBURG WASSER
ISO	International Standard Organization
m	Meter
mwc	Meters of the water column
MENA	Middle East and North Africa
KPI	Key Performance Indicator(s)
kWh	Kilo watt-hour = 1.000 Wh
ONEE	Office National de l'Electricité et de l'Eau Potable, Royaume de Maroc
p	Pressure
PDCA	Plan-Do-Act-Check
PLCM	Pump life cycle management
PS	Pump station
Q	Flow
PRV	Pressure regulating valve
Rol	Return on investment
SCADA	Supervisory Control and Data Acquisition
SONEDE	Société Nationale d'Exploitation et de Distribution des Eaux, Tunis
TWG	Technical working group
VFD	Variable frequency drive
Wh	Watt-hour
WS	Workshop
WWTP	Waste Water Treatment Plant

# 1. Background

The Arab Countries Water Utilities Association (ACWUA) is a regional network association of water utilities in the Middle East and North Africa (MENA) region. Currently the association has more than 110 members (water and wastewater utilities, water agencies, ministries, private sector) from 18 Arab countries (see Figure 1). It assists the member utilities to improve their performance in delivery of water supply and sanitation services. In order to do so the association initiated interdisciplinary technical working groups (TWGs) dealing with specific questions in priority areas of the MENA water sector to develop solutions.

The Task Force Energy Efficiency<sup>1</sup> (EE-TF) was established in 2013 at the 6<sup>th</sup> ACWUA Best Practice Conference as a response to the need to find solutions to optimize energy efficiency. Since December 2013, the GIZ supported ACWUA and the EE-TF under the scope of the programme: 'Strengthening the MENA Water Sector through Regional Networking and Training' (ACWUA WANT) to develop a guideline on energy efficiency.

The guidelines is a practically oriented step-by-step description for realizing EE improvement measures in water supply utilities of the MENA region.

It was developed in 2014 and 2015 by German consultants and experts from water sector institutions in close cooperation with the ACWUA EE-TF members. The guideline takes into account existing German, European and international standards but is specifically targeted towards present circumstances of the MENA water sector. All applied standards, norms and guidelines are referenced in chapter 12 and can serve as guidance for further improvement strategies of EE in the utilities.



**Figure 1:** The ACWUA member countries in the MENA region (source: ACWUA 2015)

<sup>1</sup> For more information on the EE-TF of ACWUA visit: <http://acwua-ee.mena-water.net/>

## 2. Introduction

Water systems are significant energy consumers and water-energy issues are of growing importance because the operating costs of water supply and wastewater treatment are determined to a large part by the energy costs. As energy costs increase strongly worldwide, the incentive for energy efficiency grows even more.

<p>The Tunisian water supplier SONEDE<sup>2</sup> Supplies water to app. 2.6 million people Is one of the biggest energy-consuming companies in Tunisia <b>SONEDE energy consumption reached 370 GWh in 2014</b> <b>Equivalent cost of 28 Million Euro</b> <b>And represents 24% of turnover of the company</b></p>	
---	---

**Figure 2:** Case study Tunisia: Cost burden for water companies due to high energy costs<sup>3</sup>

<p><b>Reasons for energy efficient operation</b></p> <ul style="list-style-type: none"><li>✓ Cost recovery (lower energy costs, lower operational costs)</li><li>✓ Improved overall operational performance (synergy creation, lower maintenance cost, longer equipment lifetime)</li><li>✓ Sustainability (resource conservation, climate change mitigation)</li></ul>
---

**Figure 3:** Reasons for EE operation (own graphic)

Energy is typically required for all process stages in water supply and wastewater treatment, but facilities are not designed and operated with energy efficiency as a principal target. The water and wastewater sector provides many options to reduce energy consumption; improve the energy efficiency and increase its own energy production.

To exploit the energy saving potential, the complex operational procedures in water supply and wastewater treatment require systematic methods of evaluating energy efficiency and the existing improvement potential for each of the process stages. Performing Energy Checks (EC), Energy Analysis (EA) and Energy Audits (EAU) in water supply and wastewater facilities is a way to identify opportunities for saving energy and costs, and thus for improving the overall operational efficiency of the utility. The final step could be the implementation of an Energy Management System (EnMS).

Benchmarking of installations or processes of the utility can already enhance an EA or an EAU and is a mandatory component of an EnMS, but this is not the focus of the present Guideline.

Key Performance Indicators (KPI) are used to quantify and evaluate energy efficiency for benchmarking as well as for Energy Check and Energy Analysis. KPIs express the specific energy consumption (or production) of machines, facilities or

<sup>2</sup> SONEDE : Société nationale d'exploitation et de distribution des eaux

<sup>3</sup> Data courtesy of SONEDE, Chief of the Energy Efficiency Department. Source: 'Lignes directrices du plan stratégique de maîtrise d'énergie à la SONEDE 2012-2030'

installations and thus allow one to specify the progress of conformance with regard to objectives, to compare similar facilities, or to evaluate success of improvement actions. The ACWUA EE-TF also developed a set of different variables and benchmarking KPIs that can be relevant for regional benchmarking exercises in the MENA region. For further details, see the ACWUA website: [www.mena-water.net](http://www.mena-water.net)

This Guideline recommends a tiered approach:

**1. Energy Check (EC):** The Energy Check is a first and rough evaluation of the energy efficiency of a single energy consumer (e.g. a pump) or a whole operating unit by using few and easily calculable Key Performance Indicators. These KPI are normally based on already available data like power consumption or water volume. The EC is usually conducted by the facility operator himself and repeated regularly (e.g. annually) to discover trends in energy efficiency and determine components with a high priority for further investigation. Provided that data are available, the EC needs only a few hours. The survey of some KPIs can also be part of daily, weekly or monthly monitoring to detect hidden dysfunctions of water or wastewater works.

**2. Energy Analysis (EA):** The Energy Analysis is a method to evaluate and improve energy efficiency for a technical system or a process step. The EA can be a stand-alone process. It comprises:

- A detailed evaluation of the energy efficiency of each energy consuming device (technical system) of a process step or of the single technical system. KPIs of the Energy Check may be used as basic information, but the EA can also be conducted without a previous EC (but then includes its KPIs) and supplementary measurements are needed to quantify power consumption and other parameters (e.g. pressure, flow rates etc.).
- An annual energy balance as a listing of all yearly energy consumptions confronted with externally obtained or self-generated energy in this period (electricity from the grid, solar panel, fuel etc.)
- A suggestion and preliminary design of short and long term improvement actions concerning the construction work, the process as such, the equipment, operation modus and status of maintenance.
- A calculation of profitability of proposed actions and proposals for further steps.

As the EA requires a lot of operational data as input for the requested calculations, the whole process of an EA may last for several months. The amount of work depends on reliability of data, the number of machines and processes to be evaluated and the number of identified actions. It can vary from a few days for a simple pumping station to several weeks for a complex water works (WW) or wastewater treatment plant (WWTP). Usually a hydraulic engineer and an electrical engineer (technician) shall be involved in the EA.

**3. Energy Audit (EAU):** An Energy Audit is an independent analysis of the energy status of an organization. Therefore it is usually conducted by external experts (consultants) but could also be conducted by an internal division, independently acting directly on special assignment under the top management. It covers the data, analysis and results of both EC and EA for different units of the organization. However, also additional information on all facilities, building systems and the

organizational procedures are required. The EAU gives a holistic overview of the energy performance of the organization and may serve as a basis for strategic decision by the top management.

An EAU forms the basis and always precedes the development of an EnMS of which it is a compulsory part, called an “energy review” in the ISO description.

**4. Energy management system (EnMS):** Thus an EAU could be considered as prerequisite to the installation of a formal Energy management system (EnMS). EnMS are based upon the process of the international Standard ISO50001. An EnMS is defined as a “set of interrelated or interacting elements to establish an energy policy and energy objectives, and processes”. The main objective of these processes is to create a self-supporting systematic approach, called a PDCA-cycle (Plan-Do-Check-Act).

This cycle asks the user to set up an organisation to repeat tasks like record energy data, analyse them, establish energy targets, control them systematically and once a year independently audit the whole system internally, to take further decisions in a review with the top management.

Figure 4 depicts the interrelation between the tools. They can be used to analyse and improve the energy consumption of a single energy consuming technical system (a machine/ installation; e.g. a pump) or a whole process step (e.g. water treatment) [tools: EC and EA] but also the overall activity field and even the whole organisation can be assessed and improvement measures implemented on this level [tools: EAU, EnMS].

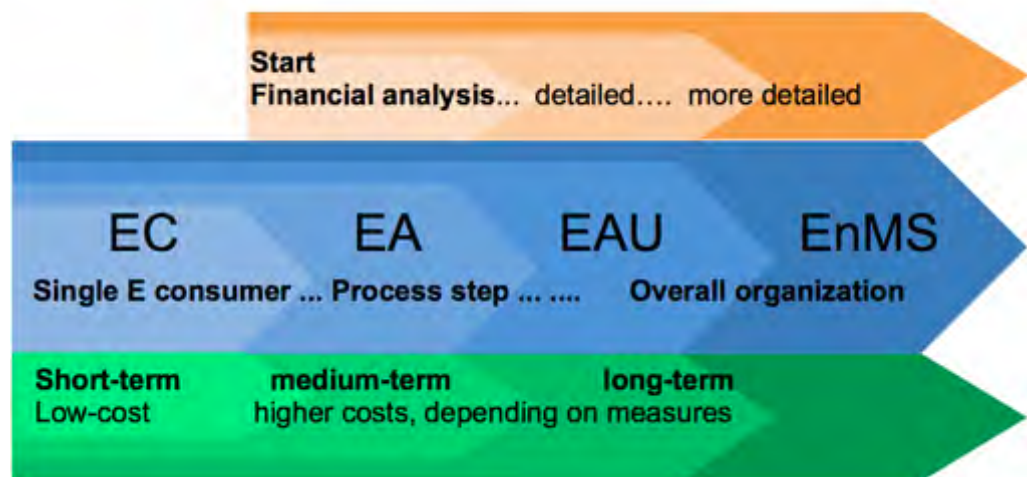

**Figure 4:** Interrelation of the tools EC, EA, EAU and EnMS (own graphic)



## **How to use this Guidance**

### 3. How to use this Guidance

This guideline is structured into 7 main steps which are shown in the following figure. It addresses interested management personnel of ACWUA member utilities who aim to start EE improvement processes in their utilities. However during the development of this guideline the involved consultant learned that central ACWUA utilities have already successfully implemented EE-improvement projects in the last decade. Those advanced utilities might focus on the more complex tools like Energy Audit and Energy Management System described in steps 5 and 6. In addition this guideline aims at creating further interest in EE improvements and also aid in applying the relevant international standards presented in the references.

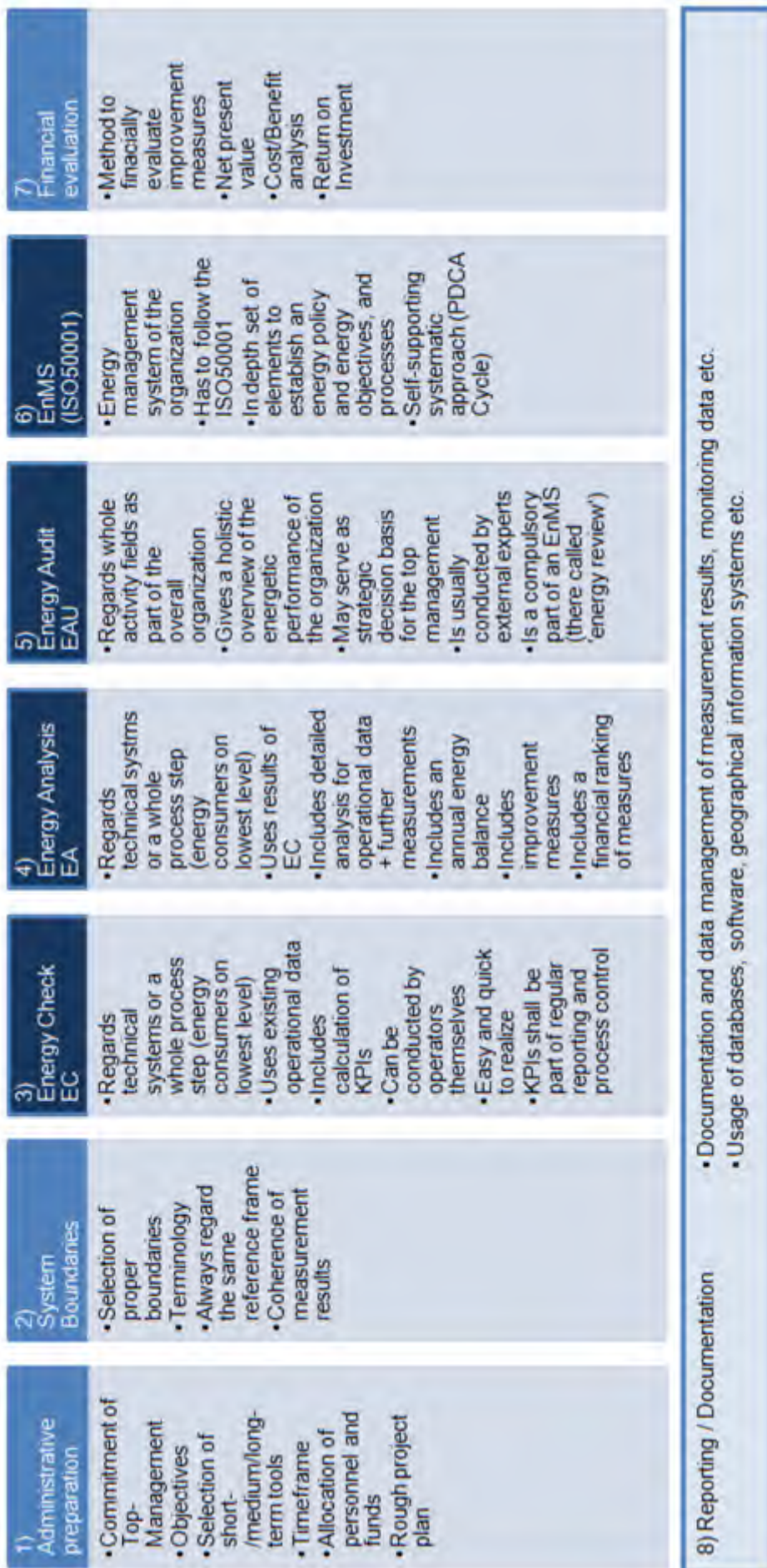

**Figure 5:** Overview of main steps of the EE guideline

## 4. Step 1 - Administrative preparation

First of all the top management has to define clear and reachable objectives and timeframes for energy efficiency improvement measures within the global policy of the utility and take the decision to act.

At the start, the top management of the organization has to demonstrate a clear commitment to evaluate the current situation and provide the necessary resources to do so. This particularly includes the appointment of an energy management representative, energy management officer or energy manager who has sufficient authority to collect and record all data and current statuses. He/she must have the required means (time, assistants, IT and, if needed, funds for measuring equipment, etc.) and appoint persons with sufficient expertise (e.g. energy management officers) to support him/her in implementing energy management tasks and activities. If necessary, an "energy team" may be established at this point, comprised of participants from the relevant departments who work under the supervision of the energy manager.

The required budget must be allocated in time and at the right place. Furthermore a rough project plan should be drawn up, containing all necessary steps and responsibilities. The plan should be kept up to date throughout the project phases. Table 1 shows the important administrative activities before starting an EE improvement process.

In this guideline a tiered approach for the EE improvement process is suggested (see Figure 4). Therefore it is recommended to define in the project plan, which tools shall be used on a short-term basis (EC, EA) and which tools are more useful to be realized on a long-term basis.

**Table 1:** Administrative requirements before starting an EE improvement process

Requirements to start EE improvement	
<b>Commitment of Top-Management to act and Improve EE situation</b>	
<b>Appointment of an energy management representative and/or energy team</b>	
<b>Budgeting and timeframe clear</b>	
<b>Rough project plan</b>	<ul style="list-style-type: none"> <li>- <b>Scope</b></li> <li>- <b>Objectives</b> <ul style="list-style-type: none"> <li>- starting with EC, EA and EAU/EnMS as long-term objective</li> </ul> </li> <li>- <b>Priorities</b></li> <li>- <b>Responsibilities</b></li> <li>- <b>Timeframe</b></li> <li>- <b>Communication/Reporting structure</b></li> </ul> <p>→ Assistance form a consultant is beneficial for the conceptualization phase of the project (if not sufficient personnel resource/capacities are available internally)</p>









## 5. Step 2 - System boundaries

A hierarchic approach is beneficial to assessing and quantifying energy consumption in a systematic way.

The water supply or wastewater company itself is the highest level (organisation) and on the 1<sup>st</sup> hierarchic level it is divided into the main activity fields: water production and water distribution or sewer system and WWTP. On the 2<sup>nd</sup> level the activity fields are subdivided into the main process steps. Each process step is composed of specific technical machines/systems which are actually the energy consuming elements on the lowest level. This hierarchic structure and the terminology as used in this guideline are shown Figure 6 for water supply and figure 9 for wastewater treatment. More detailed information is given separately for water supply and wastewater treatment in the following chapters:

### Water supply systems

Water supply systems consist of 2 major activity fields: water production and water distribution. The (administrative) buildings are not regarded for the EC and the EA as they do not belong to the technical activity field of a water supply organization. Furthermore for EC and EA only the electrical energy is regarded. Consumers of other energy forms (e.g. fleet of vehicles) are not assessed. Those consumers of other energy forms may be considered for the EAU and for the EnMS at a later stage.

Level 1 ACTIVITY FIELD	Level 2 PROCESS STEP	Level 3 TECHNICAL SYSTEMS
<b>1. Water production</b>	<b>1. Raw water extraction</b>  	Groundwater wells River/Lake intake Spring water Sea water intake
	<b>2. Raw water transmission</b> 	Pump(s) Gravity systems
	<b>3. Raw water treatment</b> 	Process steps according to the utility: Sedimentation, filtration, flocculation, coagulation, sludge treatment, disinfection, desalination etc.
	<b>4. Treated water storage</b> 	Pump(s) Gravity systems
<b>2. Water distribution</b>	<b>1. Treated water transmission from water works into network</b> 	Pump(s) Gravity systems
	<b>2. Pressure management</b> 	Booster stations, turbines, pressure regulating valves (PRVs)
	<b>3. Treated water storage in the network</b> 	(Elevated) reservoirs <i>Pumping may or may not be required</i>

**Figure 6:** Terminology and hierarchic structure of water supply systems

Please note that not all process steps necessarily exist. Many different water supply systems exist, e.g. a water supply company may directly pump spring water into the distribution system. In this case the raw water = treated water and no raw water transmission, raw water treatment or treated water storage exists at all.

Before implementing the EE improvement measures it is important to clarify which components will be investigated with which tools. Thus in step 1 'Administrative preparation' it is necessary to identify the technical systems and/or the process steps to be assessed. In the rough project plan it is important to specify which tools shall be used on a short- and medium-term basis.

It is recommended to include in the rough project plan, a table indicating the terminology and hierarchic structure of the specific water supply system of the utility as well as a graphic overview of the system as shown Figure 7.

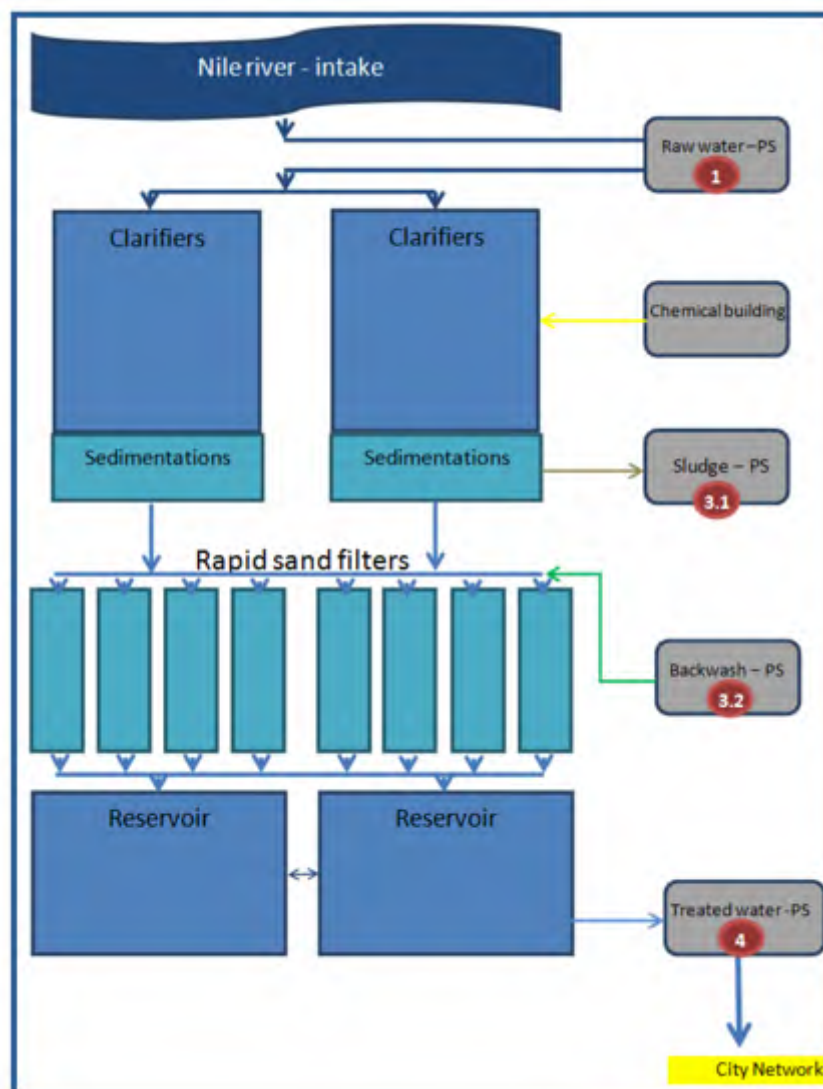

\*: Data courtesy of HCWW, Eng. Abodief, 2015, Egypt

**Figure 7:** Graphic overview of the water production process steps of MEET KHMUS Plant in Egypt

In Figure 8 again the main energy consuming process steps and options for generation of energy during the process are shown. Once more: **it is critical to always use the same reference frame (measuring points constantly at the same location) for ECs and EAs.** Otherwise the results are not comparable and quality of data is poor. Therefore it is highly recommended to document the reference frame for ECs and EAs in the build drawings or in (digital) maps as already mentioned before. Hence it is also important that the staff in charge of the EC/EA is well informed about the specific reference frame and knowledgeable of the position of measuring points.

Water treatment	
<u>Energy consumption</u> <ul style="list-style-type: none"> <li>- Water extraction and transmission to treatment facilities</li> <li>- Raw water treatment processes</li> <li>- Treated water storage</li> <li>- Buildings and construction works</li> </ul>	<u>Optional energy generation</u> <ul style="list-style-type: none"> <li>- Hydraulic energy</li> <li>- Heat energy</li> </ul>
Water distribution	
<u>Energy consumption</u> <ul style="list-style-type: none"> <li>- Treated water transmission from water works into grid</li> <li>- Pressure increase</li> <li>- Treated water storage in the grid</li> <li>- Buildings and construction works</li> </ul>	<u>Optional energy generation</u> <ul style="list-style-type: none"> <li>- Hydraulic energy</li> <li>- Heat energy</li> </ul>

**Figure 8:** Energy consumption and options for energy generation in water supply systems

**Wastewater system**

Wastewater treatment essentially consists of two separate areas of activity, namely

- the collection of wastewater via a wastewater system that is either gravity fed or has intermediate pumping stations and stormwater retention tanks if necessary
- the treatment of wastewater in wastewater treatment plants (WWTP).

Added to this may be the re-use of treated water, for example for irrigation. In this case, tertiary treatment (filtration and disinfection) should be seen as a separate step, for which the power consumption should not be included in the calculation of WWTP’s consumption.

The final pumping station of a sewer system is sometimes located on the WWTP site. In this case, it is considered an integral part of the WWTP.

In general, the energy usage figures only take into account the power consumed by the electromechanical water treatment equipment and the air-conditioning systems for the electrical control cabinets and the premises. However, the fuel consumption of any pumps run on fuel oil should also be taken into account (expressed in kWh of primary energy). Likewise, it may be useful to record the heat consumption figures for the digesters, particularly if they are heated using fossil fuel. However, the energy content of the material used for the treatment (for example flocculants, activated carbon, etc.) should not be included.

The various stages of treatment are listed in Figure 9. The rough energy analysis ('energy check') is usually carried out at the first or second level (e.g. the power consumption of a WWTP), but also at the level of the main consumers, such as the aeration tanks. The KPIs are selected according to the availability of baseline data.

Level 1 ACTIVITY FIELD	Level 2 PROCESS STEP	Level 3 TECHNICAL SYSTEMS
<b>1. Sewer system</b>	<b>1. Pump station</b>	Pump(s) Gravity systems
	<b>2. Storm water tanks</b>	Pumps, screens
<b>2. Waste Water Treatment Plant WWTP</b>	<b>1. Pump station</b>	Pump(s) Gravity systems
	<b>2. Mechanical treatment</b>	Screens, grit chamber, primary settling tank
	<b>3. Biological treatment</b>	Aeration tanks, biological filters, (aerated) lagoons, clarifier, sludge recirculation
	<b>4. Sludge treatment</b>	Thickener; anaerobic digesters, dewatering; sludge drying, incineration
	<b>5. Further treatment</b>	Odour treatment, sand filters for tertiary treatment
	<b>6. Biogas and electricity production</b>	Combined heat and power production
<b>2. Waste Water Reuse (for irrigation)</b>	<b>1. Tertiary treatment</b>	Sand filter, disinfection, storage tank
	<b>2. Pressure management</b>	Booster stations, turbines, pressure regulating valves (PRVs)
	<b>3. Treated water storage</b>	(Elevated) reservoirs <i>Pumping may or may not be required</i>

**Figure 9:** Terminology and hierarchic structure of waste water systems (own graphic)



## 6. Step 3 - Energy Check

### 6.1 Introduction

**An Energy Check is conceived as a monitoring tool, which can be applied by staff with easily available data.** Based on these measured data, the Key Performance Indicators (KPIs) can be calculated in order to evaluate the system performance. KPIs shall be monitored on a regular basis (daily/weekly/monthly readings) with at least yearly appraisal. It is recommended to set up an adequate data management, e.g. using Excel or Access databases.

An EC should be done regularly and gives hints about deviations and the need for further Energy Analysis. It is a first method using only a few KPIs. The aim is to discover changes and trends in energy efficiency and the energetic performance of a water utility's technical systems and react flexibly and speedily to the changes.

When collecting data it has to be taken into account that special national legal procedures, the electricity tariff or other specific circumstances may play an important role. It has to be considered how the specific circumstances can be met.

For the first consideration of a facility an Energy Check should be conducted by calculating easy to determine Key Performance Indicators. Comparing them with usual or target values from other facilities makes it possible to identify energy saving potentials. Evaluating the variation of these KPIs during a longer period allows recognition of the degradation of a pump station (or other equipment) efficiency and thus triggers more detailed investigations, for instance an EA. It is recommended to perform the Energy Check for all pumping stations, water treatment plants with significant energy consumption and WWTP.

As KPI quality depends largely on accuracy of input data, it is recommended to provide a first assessment of both input data and calculated KPI on local level. In particular, the plausibility of values and correct indication of units (like "mwc", "bar" or "hPa") are decisive for further interpretation. The knowledge of KPIs at the operator level also facilitates further implementation of actions for improvement. For the MENA water sector it is also very useful to collect the data centrally, because currently there is no regional database for comparison, supporting a possible later use for benchmarking as an example.

### 6.2 Water supply

The main energy consuming components in water supply are usually the pumps/pumping stations. Nevertheless the design of the transmission and distribution network also highly influences the energetic performance of a water supply system. But the redesign of a network considering smart energy efficient design criteria is very complex and costly and affects the overall supply scheme. However an EE-smart redesign of parts of the network shall be considered by the management as a long-term task and shall play a major role in infrastructure rehabilitation and extension planning. In case gravity supply is technically possible, pumping should be avoided although the initial investments for pipe lines are higher. The final design should be based on a lifecycle analysis.

On a short-term basis the most important components with highest EE improvement potential that shall be assessed with the EC are the pumping stations

of the water supply scheme (all abstraction, raw and clear water pumping stations shall be considered). In the following the EC for pumping stations is described. Generally three hierarchic levels of control related to pumps and pump stations (PS) are applied in water utilities as shown in Figure 10.

Process control of pump stations		
1 <sup>st</sup> level	Control of the service parameters (guarantee of the service to the customers)	Flow (Q) e.g. in [l/s] or [m <sup>3</sup> /h]  Pressure (p) e.g. in [mwc <sup>4</sup> ] or [bar]
2 <sup>nd</sup> level	Control concerning the compliance of the electricity tariff to avoid penalties	Electric power consumption e.g. by means of $\cos\phi$ , max. power or direct reading of electrical power [kW] and/or energy consumption [kWh]
3 <sup>rd</sup> level	Pump station performance control	Control of the overall energy efficiency [ $\eta$ ]; energy consumption [kWh]; specific energy consumption [kWh/(m <sup>3</sup> ·m)] or [kWh/m <sup>3</sup> ]

**Figure 10:** Control level for pumps and PS (source: HAMBURG WASSER)

The maintenance or replacement of faulty instruments e.g. manometers, flow meters, ampere or power meters etc. is the first precondition of regular ECs for PS. A table with conversion factors for the pressure can be found in Annex 1.

Recommended instrumentation		
Flow	Magnetic Inductive Flow (MID) meters are recommended	Accuracy: better than 1%
Pressure (suction & discharge)	Manometers for smaller PS (Figure 12), electronic pressure sensors (Figure 13 are more reliable and precise for larger PS	Accuracy better then 0.5%
Power	Ampere meter for each pump for smaller PS, Power meters for each pump for larger PS or handheld power analysers	(acc. to EN50160) for test measurements: Accuracy (power) better than 1%

**Figure 11:** Recommended instrumentation for ECs (source: HAMBURG WASSER)

<sup>4</sup> mwc or mH<sub>2</sub>O stands for 'meters of the water column' and is a unit to quantify the pressure head (and thus the internal energy of the fluid). The pressure head can also be displayed in cmH<sub>2</sub>O, psi (pressure per square inch), Pascal, bar or many other units.



**Figure 12:** Analogue pressure manometers (photos: CAH, 2015)



**Figure 13:** Pressure measurement using a portable electronic pressure sensor (Photo: CAH, 2015)

All instruments have a defined accuracy, i.e. measuring errors of these instruments have to be taken into account. Data (e.g. indicators) derived from several measurements have higher inaccuracies (calculation of error in measurement).

The performance of a PS can be analysed with the following system parameters:

Input parameters (Electrical power)	Power (kW), Current (A), Voltage (V)
Output parameters (Hydraulic power)	Flow (m <sup>3</sup> /h or l/s), Pressure (mH <sub>2</sub> O or equivalents)

**Figure 14:** System parameters for ECs of PS

The major saving potential can be normally identified in the pump performance (and not related to the motor efficiency).

It can be useful to install fixed measurement equipment for some facility components in order to allow for quick and regular ECs, but also the usage of mobile equipment is possible.

In this Guideline three KPIs will be presented to monitor the energy consumption for existing pump stations. These KPIs can be used to analyse a whole pump station in order to get an overview or for individual pumps in order to identify specific problems of a single pump.

After the first EC the pumps can be ranked according to their KPI value. The components with the worst KPI can be analysed in detail by an EA.

KPIs shall be integrated into the regular reporting schemes. It is recommended to include KPI 1 and 3 into daily reports as part of the operation control by the operators and engineers. A detailed evaluation is recommended in a yearly energy balance for the system under observation (as part of an EA). The proposed KPIs for pump stations are:

Key Performance Indicators for pump stations		
<b>KPI 1</b>	Overall efficiency	[%]
<b>KPI 2</b>	Specific energy consumption per volume and total head	[kWh/(m <sup>3</sup> *m)]
<b>KPI 3</b>	Specific energy consumption	[kWh/m <sup>3</sup> ]

**Figure 15:** KPIs for PS

#### KPI 1 - Overall efficiency of pump, motor and gear

The overall efficiency is the most important KPI. It describes the efficiency of the conversion of electric energy (input) into hydraulic energy (output). Generally something is more energy efficient if it delivers more services for the same energy input or the same services for less input.

The overall efficiency takes into account both the pump and the motor efficiency.

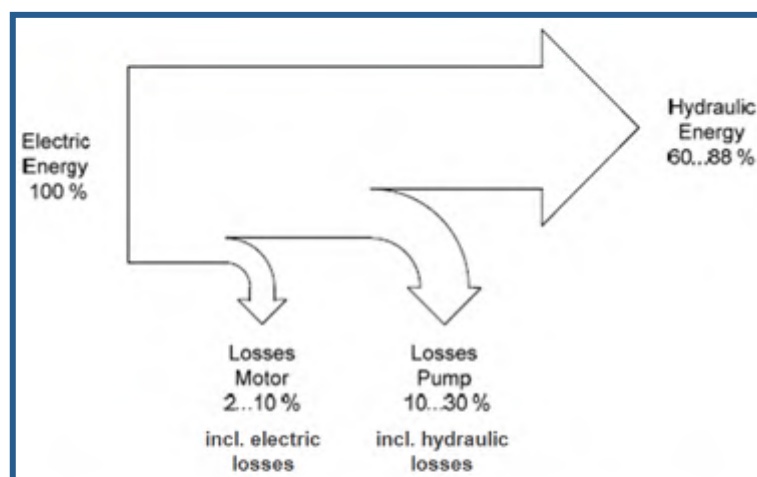

**Figure 16:** Energy conversion through pumps (graphic from HAMBURG WASSER)

**Target efficiencies for pump systems (pump + motor) for horizontal pumps:**

- 60-70% for smaller pumps [50-500 m<sup>3</sup>/h] (motor 85-90%, pump 70-75%)
- 75-85% for larger pumps (motor 95%, pump 87-89%)

**Figure 17:** Target efficiencies for pumps (source: HAMBURG WASSER)

Stable operation conditions from a PS into an elevated reservoir will guarantee higher efficiency compared with pumping conditions directly into the transmission system with larger variations in pressure. Variation in pressure or flow will affect the overall pump efficiency and also reduce the life cycle of the pump.

The formula for the calculation of KPI 1 is shown below. It is important to use the units as shown in the formula. The derivation of the formula can be found in Annex 2.

$$\begin{aligned} KPI\ 1 = \eta\ [\%] &= \frac{\text{Hydraulic Energy (Output)}}{\text{Electric Energy (Input)}} = \frac{P_{\text{Pump}}}{P_{\text{El}}} \\ &= \frac{Q\ [\text{m}^3/\text{h}] * H\ [\text{m}]}{367 * P_{\text{El}}\ [\text{kW}]} * 100\% \end{aligned}$$

**Formula 1:** KPI 1: Overall efficiency

**KPI 2 - Specific energy consumption (per m<sup>3</sup> of volume + meter head pumped)**

The KPI 2 'Specific energy consumption (per m<sup>3</sup> of volume and meter head pumped)' is measured in [kWh or Wh/m<sup>3</sup>\*m] and is an alternative way to express the overall efficiency of a pumping station (PS).

It is calculated by dividing the energy consumption of a pump or a set of pumps (pump station) by the pumped volume and the pressure head.

$$KPI\ 2 \left[ \frac{Wh}{m^3 * m} \right] = \frac{E_{\text{El}}[\text{kWh}] * 1000}{Q \left[ \frac{m^3}{h} \right] * t\ [\text{h}] * H[\text{m}]}$$

**Formula 2:** KPI 2: Specific energy consumption [Wh/m<sup>3</sup>/m]

**KPI 3 - Specific energy consumption per pumped volume**

KPI 3 is the easiest parameter to obtain for monitoring the energetic performance of pumps and/or stations. Although KPI 3 is not useful to compare different pumps/PS (it does not take the head loss into account) a monitoring of the KPI 3 allows operators and management to identify unusual changes in the consumption pattern of a pump or station. Furthermore it serves as the indicator to monitor and verify improvements of the assessed pump (station).

KPI 3 is calculated either by dividing the electrical power by the flow-rate or by dividing energy consumption in a certain time by the pumped volume.

For KPI3 the measurements of energy consumption [kWh] and flow [m<sup>3</sup>/h] are sufficient (no gauges/manometers/sensors for pressure measurements are necessary).

).

$$KPI\ 3 \left[ \frac{kWh}{m^3} \right] = \frac{P_{EI} [kW]}{Q \left[ \frac{m^3}{h} \right]} \quad \text{or} \quad KPI\ 3 \left[ \frac{kWh}{m^3} \right] = \frac{PE_{EI} [kWh]}{\left( Q \left[ \frac{m^3}{h} \right] * t[h] \right)}$$

**Formula 3:** KPI 3: Specific energy consumption [kWh/m<sup>3</sup>]

A continuous increase of KPI 3 is a clear sign of

- deviation of the operation condition from the designed specifications and/or
- damage of the pump/motor

and requires inspection and maintenance before the pump is completely damaged or a breakdown occurs.

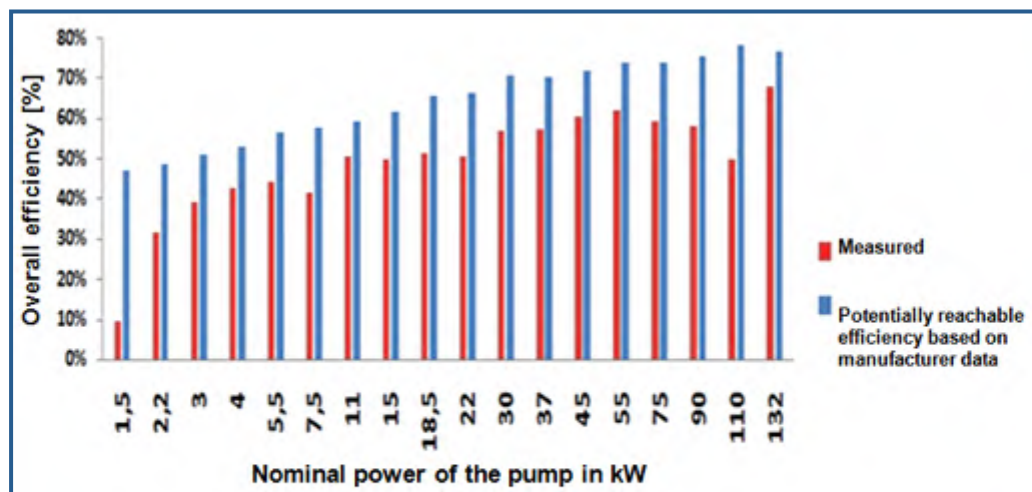

**Figure 18:** Case study Tunisia: Potential to increase the efficiency of pumps related to the nominal power<sup>5</sup>

<sup>5</sup> Data courtesy of SONEDE in Tunisia, Energy Efficiency Department, Data of 2014

In Figure 19 the calculation of the KPIs is shown exemplarily and on the subsequent pages the process is described in detail.

### Exemplary calculation of KPI 1, KPI 2 and KPI 3

- ✓  $Q = 114 \text{ m}^3/\text{h}$
- ✓ Gauge before pump: 0.92 bar
- ✓ Gauge behind pump: 8.4 bar
- ✓  $H = (8.4 \text{ bar} - 0.92 \text{ bar})^1 * 10,2 \text{ m}/\text{bar} = 76,3 \text{ m}$   
(note: 1 bar = 10,2 m H<sub>2</sub>O)
  
- ✓ Energy counter:
 

at 09:48 h	45.456.179 kWh
at 10:18 h	45.456.197 kWh
  
- ✓ Energy consumption:  $E_{El} = (45.456.197 - 45.456.179) \text{ kWh}$  in 30 min  
= 18 kWh in 30 min or 36 kWh in 1h, →  $P_{El} = 36 \text{ kW}$

$$KPI\ 1 = \frac{Q \text{ [m}^3/\text{h}] * H \text{ [m]}}{367 * P_{El} \text{ [kW]}} * 100\%$$

$$✓ KPI\ 1 = \frac{114 \text{ m}^3 * 76,3 \text{ m}}{367 * 36 \text{ kW}} = 0,658 = 66\%$$

$$KPI\ 2 \left[ \frac{Wh}{\text{m}^3 * \text{m}} \right] = \frac{E_{El} \text{ [kWh]} * 1000}{Q \left[ \frac{\text{m}^3}{\text{h}} \right] * t \text{ [h]} * H \text{ [m]}} \quad KPI\ 2 \left[ \frac{Wh}{\text{m}^3 * \text{m}} \right]$$

$$= \frac{E_{El} \text{ [kWh]} * 1000}{Q \left[ \frac{\text{m}^3}{\text{h}} \right] * t \text{ [h]} * (H \text{ discharge} - H \text{ suction}) \text{ [m]}}$$

$$✓ KPI\ 2 = 18 \text{ kWh} * \frac{1000}{\left( 114 \frac{\text{m}^3}{\text{h}} * 0,5 \text{ h} * 76,3 \text{ m} \right)} = 4,1 \frac{Wh}{\text{m}^3 * \text{m}}$$

$$KPI\ 3 \left[ \frac{kWh}{\text{m}^3} \right] = \frac{P_{El} \text{ [kW]}}{Q \left[ \frac{\text{m}^3}{\text{h}} \right]}$$

$$✓ KPI\ 3 = \frac{36 \text{ kW}}{114 \frac{\text{m}^3}{\text{h}}} = 0,316 \frac{kWh}{\text{m}^3}$$

<sup>1</sup>: in this example the total head loss is simplified to be the pressure at the discharge side – pressure at suction side. It is assumed that both pressure gauges (suction and discharge) are at the same height level and measure just before and after the pump.

Figure 19: Exemplary KPI calculation

## Process for an Energy Check

**Prerequisite:** Make sure all necessary measurement devices are available and functional (double-check if possible, e.g. with pressure loggers):

- a. Pressure gauge or logger at discharge side of pump (station)
- b. Pressure gauge or logger at suction side of pump (station)
- c. Flow meter or counter (with a counter the EC will take much longer since you need to record the counter reading (initial) and after 30 minutes calculate the flow in [m<sup>3</sup>/h])
- d. Power meter to measure the energy consumption in kW. If only a kWh-counter is available e.g. at small pump stations it is recommended to take the measurement for at least one hour. During the measurement the pump should be operated at stable conditions. The exact time including seconds must be recorded when the kWh-counter is read.

**Measurement procedure:** Measure for different combinations of pumps the following parameters:

- 1) pressure/head at suction side
- 2) pressure/head at discharge side
- 3) flow [m<sup>3</sup>/h]
- 4) electrical power [kW] or energy consumption [kWh]

Allow the measurement to stabilize for some minutes before taking the reading. Always measure the configuration of no pumps and all pumps in operation.

Measure and record the difference in height between pressure gauge of suction and discharge side.

**Duration:** Depending on the configurations to be assessed the measurement will take around 1-3 hours.

### **Analysis of data:**

- a. Insert all measurement reading results including the units in an Excel file
- b. Convert into the units: m<sup>3</sup>/h for flow and mH<sub>2</sub>O for head/pressure
- c. Calculate KPI 3 'Specific energy consumption per volume' [kWh/m<sup>3</sup>]
- d. Calculate the total head:  $H = H_{\text{discharge}} - H_{\text{suction}} + \text{height difference of gauges} + \text{sum of friction losses in PS}$
- e. Assume a value for the friction losses in the PS between 0.5m – 2m
- f. Note: For wells use the dynamic water level in order to calculate the total head.
- g. Calculate KPI 1 'Overall efficiency' [%]
- h. Calculate KPI 2 'Specific energy consumption (per m<sup>3</sup> of volume and meter head pumped)' [Wh/m<sup>3</sup>\*m]
- i. **Note:**



Energy can be measured in different units. If the energy is being transmitted or used at a constant rate (power) over a period of time, the total energy in kilowatt-hours is the product of the power in kilowatts and the time in hours. The kilowatt-hour is commonly used as a billing unit for energy delivered to consumers by electric utilities. In Table 2 the conversion of different energy units is displayed.

**Table 2:** Conversion of energy units (source: HAMBURG WASSER)

	<u>joule</u>	<u>watt hour</u>	<u>kilowatt hour</u>	<u>electron volt</u>	<u>calorie</u>
1J=1 kg·m <sup>2</sup> s <sup>-2</sup> =	1	2.77778 × 10 <sup>-4</sup>	2.77778 × 10 <sup>-7</sup>	6.241 × 10 <sup>18</sup>	0.239
1 W·h =	3,600	1	0.001	2.247 × 10 <sup>22</sup>	859.8
1 kW·h =	3.6 × 10 <sup>6</sup>	1,000	1	2.247 × 10 <sup>25</sup>	8.598 × 10 <sup>5</sup>
1 eV =	1.602 × 10 <sup>-19</sup>	4.45 × 10 <sup>-23</sup>	4.45 × 10 <sup>-26</sup>	1	3.827 × 10 <sup>-20</sup>
1 cal =	4.1868	1.163 × 10 <sup>-3</sup>	1.163 × 10 <sup>-6</sup>	2.613 × 10 <sup>19</sup>	1

### Water treatment

Water treatment for drinking water uses pumps as well (usually in smaller dimensions), which have a potential for energy savings and can be treated as described. The choice of water resource already has an influence on the energy consumption, e.g. the usage of groundwater under normal circumstances requires much less energy than river water with treatment.

Water treatment and its specific energy consumption depend on the raw water quality and the chosen treatment. Specific energy consumption will be lowest for standard treatment methods like chlorination and rapid sand filtration (0,1 – 0,6 Wh/m<sup>3</sup>). It increases with more sophisticated treatment methods like micro filtration (40 – 200 Wh/m<sup>3</sup>) to nano filtration (300-500 Wh/m<sup>3</sup>). The highest energy consumption is required for reverse osmosis. There are too many treatment methods to be described in detail in this guideline. However in general the same principles for Energy Checks and Energy Analysis are valid for the components of water treatment.

## 6.3 Wastewater collection and treatment

### Introduction to the methodology

In wastewater systems, the aims and basic principles of the energy check (EC) remain the same: to evaluate the energy efficiency of the wastewater treatment system using key performance indicators (KPIs) that are easy for the plant manager to calculate based on existing operating data. But the detailed procedure is slightly different from that used in the drinking water sector for the following reasons.

Firstly, a wider range of procedures and equipment are used to treat wastewater and sludge, making it harder to select the KPIs. In order to allow a first (and rough) evaluation of the energy efficiency - without detailed investigations - some impacts of waste water quality or technical features of the WWTP, are not taken into account for the EC. But their influence should be considered when carrying out an EA. For this reason, the KPIs for wastewater systems are generally cruder and relate to a whole process or even the entire WWTP. The processes and major consumers to be considered are listed in Chapter 5 (Fig. 9). The electricity consumed in the treatment of wastewater is usually proportional to the average pollutant load entering the WWTP, and consequently most of the KPIs state energy consumption (and biogas production) in WWTPs as a population equivalent (PE) figure. Once the specific energy consumption has been normalised in this way, it is easy to compare it with that of other plants.

But among this energy-consuming equipment there are also plenty of pumping stations in wastewater systems and WWTPs for which the consumption depends not only on the chemical oxygen demand (COD), but also on the quantity of wastewater pumped and the manometric head of the discharge. So we have retained the same KPIs as those used in drinking-water pumping stations. But the energy performance, particularly of sludge pumps (for recycling sludge, thickener feed, etc.) and pumping stations for untreated wastewater, is significantly lower because the pumps have to be fitted with different (less efficient) impellers to enable solids to pass freely so as to prevent blockages. For this reason, the same KPIs can be calculated as described in the previous chapter (KPI 1 to 3), but a different scale needs to be chosen to evaluate the values. The overall efficiency of the pumps (including the efficiency of the drive and motor) rarely exceeds 50%, compared with over 80% for drinking-water pumps.

The key performance indicators are presented below in accordance with the methodology used in the German DWA A 216 standard, using relative frequency of occurrence curves based on surveys carried out in Germany between 2010 and 2015 (see Figure 20 to Figure 23). Experience in several European and Arab countries has shown that the frequency curves of values are valid at first glance, apart from some differences in procedural detail, provided the calculation method and choice of units are correct. Since most of the energy efficiency KPIs relate to the load entering the WWTP (expressed in terms of population equivalents (PEs)), it makes sense to define the calculation of the total load and the conversion using PE as the base unit. This also applies to detailed energy analysis.

## Basis for calculating KPIs

In industrialised countries, 1 PE is usually defined as a unitary load of 120 g/day COD (chemical oxygen demand) or alternatively 60g/day BOD<sub>5</sub> (biochemical oxygen demand within five days). However, in the Middle East and North Africa, PE ratios of 70 to 100 g/day COD or 35 to 50 g/day BOD<sub>5</sub> are also used. Hence, in order to compare KPIs, it is very important to carefully specify and indicate the basis for calculating 1 PE. For example, 1 PE<sub>120gCOD</sub> means that the pollutant load expressed in PEs is calculated based on 120 g/day COD per PE.

Similarly, the number of PEs may relate to the design load for a WWTP (e.g. the nominal capacity of the WWTP = 100,000 PE), or alternatively the load (average or peak) measured during operations, which is normally less than the nominal capacity (e.g. 70,000 PE). So when analysing energy usage, we always refer to the **average annual load entering the WWTP**, expressed in kg/day or in PE, excluding the flowback from sludge treatment. Sampling can be carried out after screening or even downstream from the grit chambers, but not after primary sedimentation. To measure the average load, it is highly advisable to use automatic samplers commensurate with the flow rate and include analyses from an entire year. As a rule, the wastewater treatment KPIs should only be calculated annually, so as to even out any daily and seasonal variations.

The amount of power consumed by the WWTP or by any equipment during the year is therefore divided by the number of PEs to get the specific annual consumption in [kWh/(PE.a)]. To compare the specific power consumption with that of other WWTPs, you need to use the same basis for calculating one PE, and it is always helpful to indicate right at the start the ratio used (e.g. 1 PE<sub>45gBOD</sub> = 45g/day BOD<sub>5</sub>) to enable other people to convert their units. To compare KPIs using the relative frequency curves shown below, you should use a ratio of either 60g/day BOD<sub>5</sub> or 120g/day COD, or alternatively calculate the specific consumption in kWh per kg of COD or BOD<sub>5</sub> (see Table 3).

<b>1 PE =</b>	120 g/day COD	100 g/day COD	90 g/day COD	80 g/day COD
<b>1 PE =</b>	60 g/day BOD <sub>5</sub>	50 g/day BOD <sub>5</sub>	45 g/day BOD <sub>5</sub>	40 g/day BOD <sub>5</sub>
<b>1 kWh/kg BOD<sub>5</sub>=</b>	22 kWh/PE.a	18 kWh/PE.a	16.5 kWh/PE.a	14.6 kWh/PE.a
<b>1 kWh/kg COD =</b>	44 kWh/PE.a	36.5 kWh/PE.a	33 kWh/PE.a	29 kWh/PE.a

**Table 3:** Unit conversion for KPIs in WWTPs

For example, if the average load entering the WWTP is 3,150 kg/day BOD<sub>5</sub> and the annual electricity consumption of the WWTP is 1,500,000 kWh/a, the specific consumption of the WWTP will be 1.3 kWh/kg BOD<sub>5</sub> (1,500,000 kWh / (365 days/year \* 3,150 kg/day BOD<sub>5</sub>)). If 1 PE equals 45 g/day BOD<sub>5</sub>, the specific consumption per PE will amount to 21.5 kWh/PE.a (= 1.3 \* 16.5 kWh/PE.a). If 1 PE equals 60 g/day BOD<sub>5</sub>, the specific consumption per PE will amount to 28.6 kWh/PE.a (= 1.3 \* 22 kWh/PE.a).

## Collecting baseline data

To calculate the KPIs proposed below, you first of all need to collect the following operational data:

### For all WWTPs:

- ✓ Average pollutant load **L** in kg/day COD (or alternatively BOD<sub>5</sub>) entering the WWTP
- ✓ Total electricity consumption  $E_{\text{tot}}$  [kWh/a] from the supplier's invoice or electricity meter
- ✓ Amount of fuel oil or gas used for heating or as fuel for engines in machinery installed in the WWTP (but not vehicles).

### For WWTPs with aeration tanks:

- ✓ Electricity consumption of the aeration system  $E_{\text{aer}}$  (either surface aerator or booster pumps without agitators) in [kWh/a] as measured by the electricity meter or based on operating hours and power consumed
- ✓ In the case of fine bubble aeration, it may also be useful to make a note of the air pressure upstream from the booster pumps [mbar] and the height of the water column on top of the diffusers [m].

### For WWTPs with digesters:

- ✓ Quantity of biogas produced  $Q_{\text{gas}}$  in m<sup>3</sup>/a under standard conditions (0°C, 1013 mbar).
- ✓ Quantity of raw sludge injected into the digester  $Q_{\text{DM}}$  (annual average) in kg/day DM (dry matter) and average percentage of volatile material (loss on ignition, LOI)
- ✓ Calorific value of biogas [kWh/m<sup>3</sup>] or methane content [%]
- ✓ Power produced from cogeneration based on biogas  $E_{\text{cog}}$  [kWh/a]
- ✓ Quantity of biogas used for cogeneration  $Q_{\text{cog}}$  in m<sup>3</sup>/a

### For main pumping stations:

- ✓ Total electricity consumption  $E_{\text{tot}}$  [kWh/a] from the supplier's invoice or electricity meter
- ✓ Manometric head  $h_{\text{man}}$  [m]
- ✓ Quantity of water (or sludge) discharged  $Q_{\text{water}}$  [m<sup>3</sup>/a]

## Calculating KPIs

To perform an energy check on WWTPs, the following KPIs are suggested. These are based on the data listed above.

Key performance indicators for WWTPs		
$e_{\text{WWTP}}$	Specific power consumption of the WWTP	[kWh/PE.a]
$e_{\text{aer}}$	Specific power consumption of the aeration system	[kWh/PE.a]
$y_{\text{gas}}$	Specific production of biogas per kg of organic material fed into the digester	[lN/kg OM]
$A_{\text{gas}}$	Percentage of the biogas produced that is used for cogeneration	[%]
$\mu_{\text{el}}$	Electricity output from cogeneration	[%]
$A_{\text{el}}$	Degree of self-sufficiency	[%]

**Table 4** Key performance indicators for WWTPs

The first step is always to calculate the number of PEs based on the average load **L** divided by the ratio chosen according Table 3. For comparability with international reference values (see Figures 20 - 23), it makes sense to calculate PEs based on a ratio of 60g/day BOD<sub>5</sub>. An explanation of how to calculate the KPIs is shown below using typical values for an activated sludge WWTP with digester and cogeneration.

For example, if the load **L** = 4,500 kg/day BOD<sub>5</sub>

$$\rightarrow \text{Load expressed as PEs} = 4500 * 1000 / 60 = 75,000 \text{ PE}$$

And the total power consumption of the WWTP  $E_{\text{tot}}$  is 2,250,000 kWh/a:

$$\rightarrow e_{\text{WWTP}} = 2,250,000 / 75,000 = 30 \text{ kWh/PE.a}$$

Note that in the case of cogeneration or any other type of self-generated power (e.g. solar panels), the power consumption of the WWTP will be the sum of the power bought in plus that produced by the WWTP itself.

Similarly, if the power consumption of the aeration system  $E_{\text{aer}}$  is 1,750,000 kWh/a, the specific consumption is calculated as follows:

$$\rightarrow e_{\text{aer}} = 1,750,000 \text{ kWh/a} / 75,000 \text{ PE} = 23.3 \text{ kWh/PE.a}$$

For WWTPs with digesters, you first of all need to calculate the quantity of organic matter fed into the digester based on the volume of raw sludge, the dry matter content and the loss on ignition. With 150 m<sup>3</sup>/day of raw sludge, a DM content of 45 g/l and a loss on ignition of 65%, the organic matter load  $Q_{\text{OM}}$  will be  $150 * 45 * 0.65 = 4,388 \text{ kg/day}$ . With a biogas quantity  $Q_{\text{gas}}$  of 640,000 m<sup>3</sup>/a (under standard conditions), the specific production will be

$$\rightarrow y_{\text{gas}} = 640,000 \text{ m}^3/\text{a} * 1,000 \text{ l/m}^3 / 365 \text{ days/yr} / 4,388 \text{ kg/day} = 400 \text{ l/kg OM}$$

Of course, the percentage of biogas used for cogeneration  $A_{\text{gas}} (= Q_{\text{cog}} / Q_{\text{gas}})$  should be close to 100% to benefit fully from the renewable biogas energy and to use less power from the public network. The amount of electricity produced by cogeneration is calculated based on the quantity of biogas used  $Q_{\text{cog}}$  and the

calorific value of the biogas in kWh/m<sup>3</sup>. This will depend essentially on how much methane the biogas contains. If it is 10% methane, the calorific value of the biogas can be assumed to be 1 kWh/m<sup>3</sup>. For the example shown and assuming that all the biogas that is produced is used, the primary energy of biogas with a methane content of 60% will therefore be 640,000 m<sup>3</sup>/a \* 6 kWh/m<sup>3</sup> = 3,840,000 kWh/a. If 1,421,000 kWh/a of power is produced from cogeneration, the electricity output from cogeneration will be

$$\rightarrow \mu_{el} = 1,421,000 \text{ kWh/a} / 3,840,000 \text{ kWh/a} = 0.37 \text{ (=37\%)}$$

Dividing the power produced by the total consumption of the WWTP gives the degree of self-sufficiency:

$$A_{el} = 1,421,000 \text{ kWh/a} / 2,250,000 \text{ kWh/a} = 0.63 \text{ (= 63\%)}$$

#### Notes:

- The KPI values calculated in these examples are shown in the form of frequency curves (see Figure 20 -23)
- If the WWTP uses engines powered by fuel oil or gas in its operations, you need to add into the calculation for WWTP KPI the equivalent in kWh of the fuel consumption of the engines for the on-site machinery (but not the vehicles!). You can allow 10 kWh per litre of fuel and per cubic metre of natural gas.
- Obviously the reference values for the specific power consumption imply that the wastewater treatment is carried out under the correct operating conditions, in other words, the threshold values are observed, the treatment efficiency is greater than 90% for COD and BOD<sub>5</sub>, and all the equipment is in good working order. If any energy-consuming machinery (e.g. surface aerators, agitators, etc.) is out of action for several months of the year, you should extrapolate the power consumption for the periods of normal operation to cover the entire year.
- If the treatment efficiency is very low (e.g. due to a surcharge, or aeration being voluntarily limited), power consumption should be calculated in relation to the pollutant load that is actually removed.

#### Plausibility checks

Since calculating KPIs often involves converting units, you should first check the order of magnitude for the values calculated. It is highly unlikely that a KPI value will be ten or 100 times greater than the average reference values shown in the figures and tables. If this happens, you should check whether the units have been correctly used, or whether any other mistakes have been made in the calculations.

For the pollutant load, you can calculate the number of PEs based on the ratios for COD, BOD<sub>5</sub>, P<sub>tot</sub> (1.8 g/day.PE) and the specific quantity of sludge ( 40 to 60 g/day.PE). If the resulting PE figure varies significantly (e.g. >30%) depending on the parameter used, there must be a mistake or some specific conditions that will need verifying (e.g. the influence of industrial effluents).

Similarly, the ratio between the COD load and the BOD<sub>5</sub> load should be somewhere between 2:1 and 2.5:1, and the BOD<sub>5</sub> load should not be greater than the COD load.

For biogas production you can check the gas meter reading by measuring how long it takes to fill the gas holder after having turned off all the biogas consumers.

### Evaluating KPIs using relative frequency of occurrence curves

For several of the suggested KPIs, data from German WWTPs has been systematically analysed to generate relative frequency of occurrence curves (see Figures xxxx, taken from the DWA A 216 publication, 2015). These curves can be used as reference values for an initial evaluation of WWTP energy efficiency by comparing the value calculated during the energy analysis with the relative frequency curve.

Broadly speaking, the median values (in other words, the values that are exceeded by half the WWTPs) represent a level of efficiency that can usually be achieved by optimising the WWTP's energy consumption using affordable measures. Moreover, the value achieved by just 10% of WWTPs represents an optimum target value that can only be achieved if the WWTPs are designed, constructed and operated in accordance with the highest technical standards.

Although it is not possible to use the KPIs to directly quantify potential savings, the probability of identifying affordable optimisation measures increases significantly the further away from average the value lies.

But beware of specific electricity consumption values that are very low. If the figure calculated is lower than the target figure, it is highly likely that the plant is not being operated correctly or a mistake has been made in the calculation. KPI frequency curves are shown below, together with some explanatory comments.

### KPI $e_{\text{WWTP}}$

For total WWTP power consumption, the large number of WWTPs surveyed has made it possible to differentiate the frequency curves depending on the treatment procedure used. If the sludge is treated solely by gravity thickening and dewatering on drying beds, the values for WWTP KPI 1 may be lower (close to 20 kWh/a.PE<sub>120gCOD</sub>). For the example shown with a specific consumption of 30 kWh/PE.a, the curve indicates that only 33% of WWTPs of the same category are more energy-efficient, in other words, have a lower specific consumption figure.

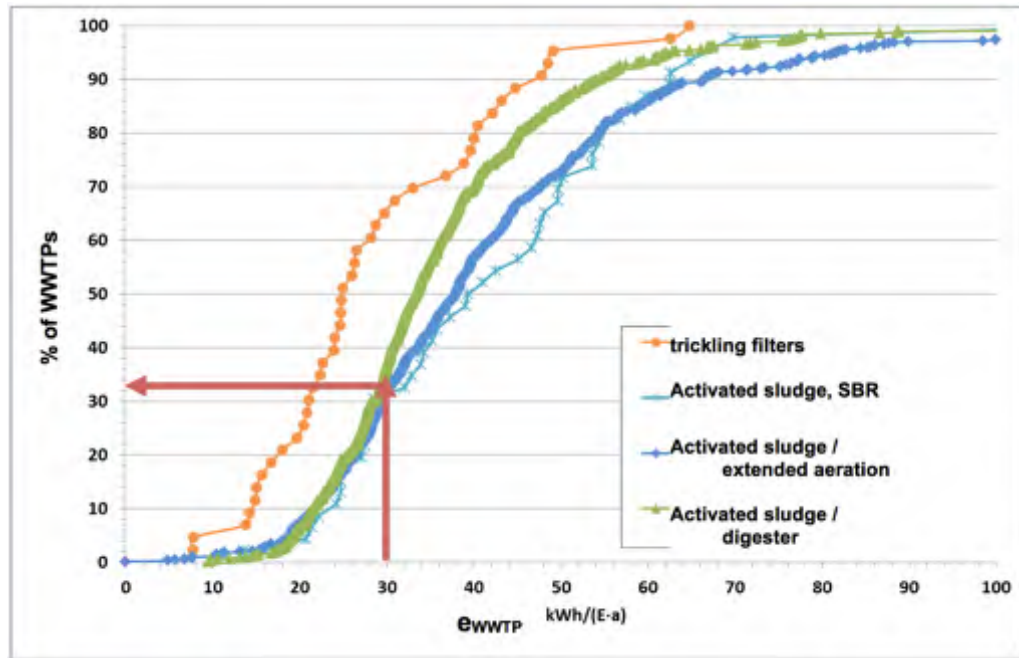
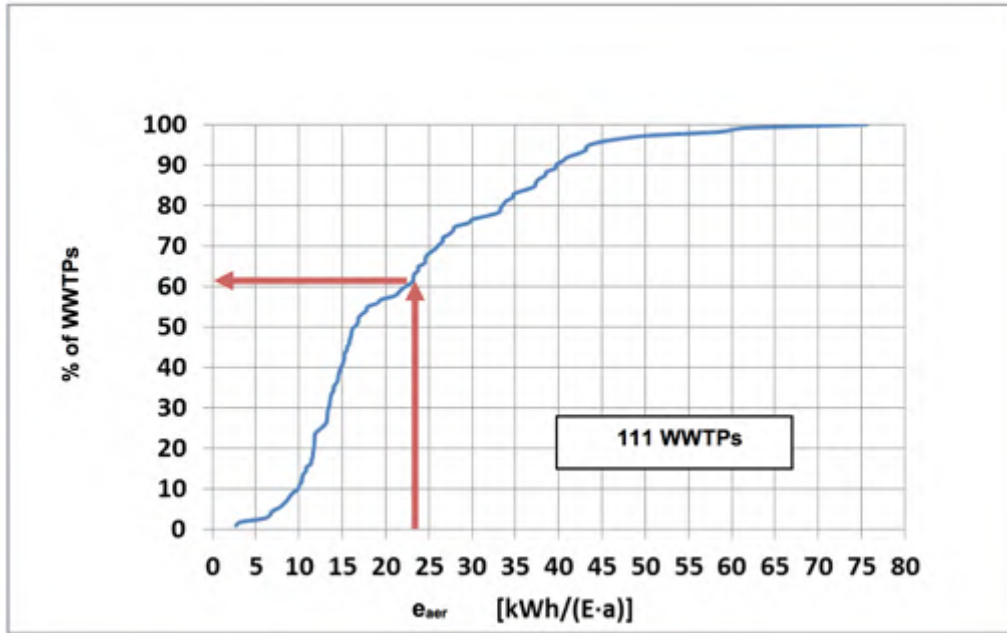

**Figure 20:** Frequency curve for specific power consumption for the entire WWTP eWWTP

#### KPI $e_{aer}$

The values for aeration system power consumption mostly come from WWTPs with fine bubble aeration. For aeration systems that use surface aerators, the values for the **KPI  $e_{aer}$**  are around 30% to 50% higher. Irrespective of absolute values, the **KPI  $e_{aer}$**  is particularly useful for checking changes in the performance of the aeration system over time. For fine bubble aeration, it is therefore possible to detect any deterioration in the efficiency of the diffusers. Aside from any changes in the **KPI  $e_{aer}$** , the pressure upstream from the booster pumps can also assist in drawing conclusions regarding the current state of the diffusers. For the example shown with a specific consumption of 23.3 kWh/PE.a, the curve indicates that 60% of aeration systems in the same WWTP category are more energy-efficient.

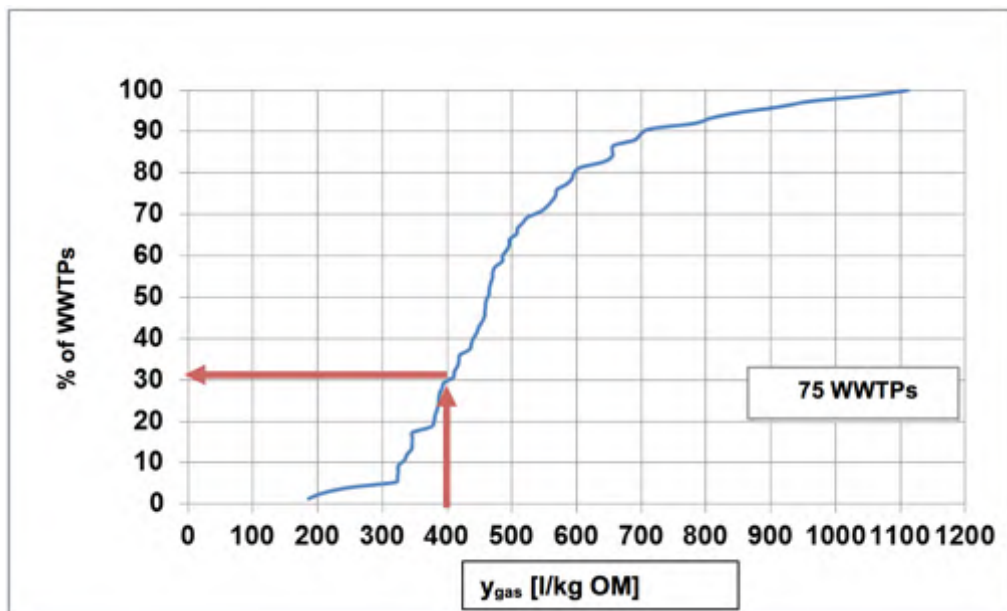



**Figure 21:** Frequency curve for the specific power consumption of aeration  $e_{aer}$

### KPI $y_{gas}$

For the example shown with a specific production of 400 l/kgOM, the curve indicates that just 30% of digesters have a lower specific production figure, but 70% of digesters have a higher production figure and are therefore more efficient.



**Figure 22:** Frequency curve for the specific production of biogas KPI  $y_{gas}$

## KPI $A_{el}$

For the example shown with a 63% degree of self-sufficiency, the curve indicates that 80% of WWTPs are less self-sufficient and only 20% are more energy-efficient in terms of this indicator.

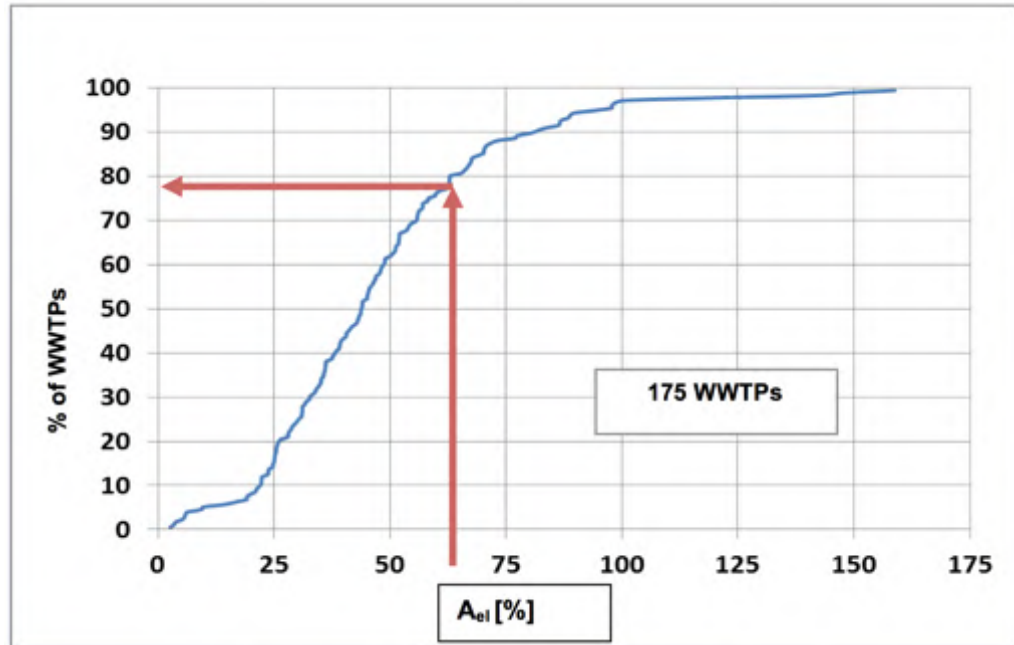

**Figure 23:** Frequency curve for electrical self-sufficiency in WWTPs

For the electrical efficiency of cogeneration there are no frequency curves but instead we have provided an overview of the cogeneration modules available on the market, for which information is summarised in the following table.

Power [kW <sub>el</sub> ]	Electrical efficiency [%] <sup>1)</sup>			Thermal efficiency [%]		
	Diesel engine	Spark-ignition engine	Gas micro-turbine <sup>2)</sup>	Diesel engine	Spark-ignition engine	Gas micro-turbine <sup>3)</sup>
1-30	-	30 - 31	26 (24)	-	54-70	59
Up to 50	40	32 - 35	26 (24)	53	47-55	-
Up to 100	40	35 - 39	29 (27)	50	43-55	56
Up to 250	40 - 43	38 - 40	33 (31)	39 - 40	40-54	52
> 250	43 - 45	40 - 43	-	36 - 43	40-52	-

1) Values are based on total power production without the consumption of the cogeneration unit itself  
2) Values in brackets are calculated by taken into account the power consumption of an additional gas blower, needed for micro-turbines

**Table 5** Key performance indicators for cogeneration modules

For WWTP pumping stations, the specific power consumption of the pumps [Wh/m<sup>3</sup>.m] and the total output for the pumping stations [%] can be calculated as described in section 6.2. However, the values should be interpreted using a different scale.

Type of pump	Use	Type of impeller	Total output $\eta_{tot} = \eta_P * \eta_{Mot.}$ (-)	Spec. cons. $e_{spec}^{*})$ Wh/(m <sup>3</sup> ·m)
Archimedean screw	Crude wastewater		<b>0.50 - 0.60</b>	<b>5.4 - 4.5</b>
	Recycled sludge		<b>0.60 - 0.70</b>	<b>4.7 - 3.9</b>
Centrifugal pump	Crude wastewater	Multi-vane open impeller	<b>0.4 - 0.55</b>	<b>6.8 - 4.9</b>
	Settled sewage Internal recycling	Non-clogging impeller	<b>0.55 - 0.75</b>	<b>4.9 - 3.6</b>
Propeller pump	Internal recycling		<b>0.6 - 0.80</b>	<b>4.7 - 3.4</b>
Vane pump	Sludge (thick)		<b>0.50 - 0.65</b>	<b>5.4 - 4.2</b>
*) Specific consumption $e_{spec} = 2.7 \text{ Wh}/(\text{m}^3 \cdot \text{m}) // \eta_{tot}$				

**Table 6:** Total output for wastewater and treatment sludge pumps



## 7. Step 4 - Energy Analysis

### 7.1 Introduction

**The Energy Analysis (EA) is an evaluation of the energy performance, which goes more into detail than an Energy Check and is focused on developing improvement measures.** As explained in the introduction, EA starts with an inventory of all major energy consuming machines and processes in order to examine their part of total consumption and their energy efficiency. For the conception of improvement measures the energy analysis is not limited to technical data of machines, but it has to consider the overall technical system, the construction works, the process data (flow rates, quality of water treatment etc.), the equipment, operation modus and status of maintenance. For instance the pressure head of a pumping station depends on the way reservoirs are constructed and on the design/dimensioning of pipelines (flow velocity). But energy efficiency of a water works can also be deteriorated by water leakage in the network or a lack of maintenance.

Although basic principles of an EA are similar for water works and wastewater systems, there are specific particularities in the method of EA for wastewater treatment which makes it helpful to describe the process of an EA separately for both applications.

### 7.2 Energy Analysis in water works

The **process for an EA of a water works** is shown Figure 24.



**Figure 24:** Process for the EA, exemplary for PS (pump stations)

## Baseline Assessment

To avoid wrong interpretation of KPIs it is important to check available data according to the following questions:

- What measurements and which data already exist?
- Is this measurement plausible?
- What further measurements are needed?

To evaluate the potential for improvements the following questions can be asked throughout the course of the data acquisition process:

- How has the energy consumption changed over the past years; are there trends and can they be explained?
- What are the largest energy consumers, and did I expect that?
- Where might there be potentials that can be identified through further measurements (load profiles)?
- What variables (could) affect my energy consumption?
- What energy pricing structure do I have and is it appropriate for the production?
- Can renewable/regenerative or CO<sub>2</sub>-neutral energies be used as alternatives?

If weak points are identified, for instance by analysing KPIs, subsequent improvement measures have to be developed including a rough estimation of (supplementary) costs of operation and investment. In Step 7 there are some examples of how to do financial evaluation and ranking of measures.

The Energy Analysis should be implemented after the first Energy Check, especially when KPIs are not satisfying. In most water supply systems, pumping stations are the most important energy consumers. Therefore they are used as an example for the execution of an EA. Water treatment plants can be examined in a similar way.

If improvement measures are executed, it is important to implement follow-up monitoring in order to verify energy savings and operation costs and thereby motivate further efforts.

## Detailed evaluation of the system

Each pump as well as all technical equipment has its life cycle. To evaluate if an asset is efficient in terms of cost-benefit it is therefore important to consider the overall life cycle costs (LCC) referring to the total cost of ownership over the life of the asset. Costs considered include financial costs but also environmental costs, which are more difficult to quantify and assign numerical values. The typical LCC for a pump are shown in **Figure**.

The technical designed period of a pump is about 15 to 20 years, if all operation conditions are respected. The financial evaluation is normally done for 10 years (depreciation time). However, the operation conditions are substantial for the life span of a pump. Regular and complete maintenance of all mechanical and hydraulic parts using original spare parts can extend the life span of a pump far beyond the initial design period.

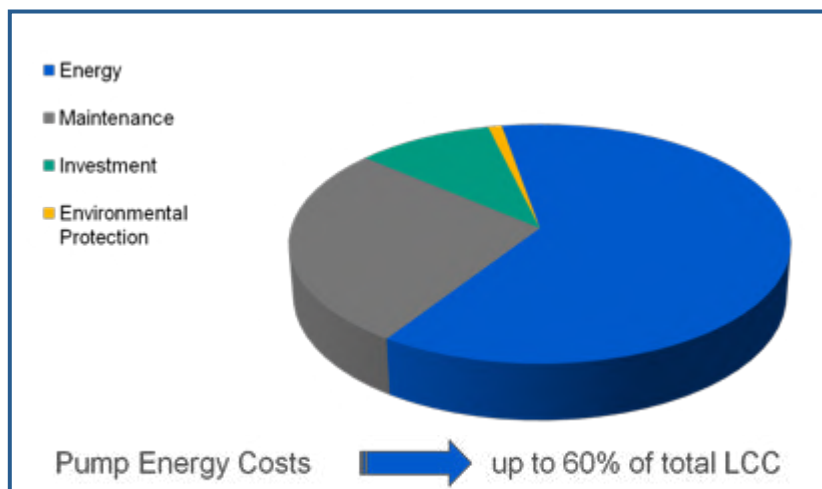

**Figure 25:** Typical LCC of a pump (source: WILO 2014)

The Energy Analysis requires a complete evaluation of the individual PS including its transport systems, in order to verify the designed specifications versus the actual operation conditions. For the EA of the pumps the KPI 1 and 2 from the Energy Check can be used.

KPI 1 (pump system efficiency) is the most important parameter. Measurements can be compared with the original data provided from the data sheets of the manufacturer. These data sheets are part of the original contract. It must be verified that the pumps are still working within the area of the “Best Practice” or “Better Practice” for shorter periods (see below) in order to guarantee a long lifecycle with high efficiency.

The verification of the design specifications against the actual operation conditions are important tasks of the EA of a pump station.

First of all the “system curve<sup>6</sup>” has to be determined for the pumping system under assessment. To derive a system curve, the results of the EC can be used. Different combinations of pumps in operation shall be measured, see Figure 26.

<sup>6</sup> The system curve represents the head requirements of a system as a function of the flow rate

Ciceron		30.03.2015		assumed friction losses in m: 0,8						diff in gauge height in m: -							
No.	P1	P2	P3	P5	power	flow	suction level	dis-charge press-ure	dis-charge press-ure	power	suction press-ure	dis-charge press-ure	Spec. energy consumption	head	over-all eff.	mid over-all eff.	avg overall eff. w/o P1
	cv?	cv?	cv?	cv?	kW	m <sup>3</sup> /h	ft	m	psi	kW	m H <sub>2</sub> O	m H <sub>2</sub> O	kW / m <sup>3</sup>	m	%	%	
measurements										calculations							
10	Off	Off	Off	Off	8,5	-16,0	12,3	106,8	157	0,0	2,0	106,8	0,000	105,6			
9	On	Off	Off	Off	48,7	61,5	12,3	112,2	164	40,2	2,0	112,2	0,654	111,0	46,3		
3	Off	On	Off	Off	47,5	69,0	12,6	112,2	164	39,0	2,1	112,2	0,565	110,9	53,5	54,1	56,7
5	Off	Off	On	Off	53,9	83,0	12,4	112,3	164	45,4	2,0	112,3	0,547	111,1	55,3		
11	Off	Off	Off	On	53,6	91,2	12,3	112,3	164	45,1	2,0	112,3	0,494	111,1	61,3		
2	On	On	Off	Off	89,2	145,0	12,5	112,8	166	80,7	2,1	112,8	0,557	111,5	54,6		
8	On	Off	On	Off	91,0	159,0	12,3	112,9	165	82,5	2,0	112,9	0,519	111,6	58,6		
12	On	Off	Off	On	93,0	166,3	12,3	113,1	166	84,5	2,0	113,1	0,502	111,9	60,7	59,9	61,0
4	Off	On	On	Off	95,7	186,5	12,6	113,0	165	87,2	2,1	113,0	0,523	111,7	58,2		
13	Off	On	On	Off	84,4	175,2	12,2	113,1	166	85,9	2,0	113,1	0,490	111,9	62,2		
6	Off	Off	On	On	96,9	189,0	12,4	113,3	166	88,4	2,0	113,3	0,467	112,0	65,3		
16	On	On	On	Off	138,3	239,3	12,0	113,9	167	129,8	1,9	113,9	0,543	112,8	56,6		
1	On	On	Off	On	134,3	249,0	12,5	112,8	166	125,8	2,1	112,8	0,505	111,5	60,2	61,0	63,6
7	On	Off	On	On	134,7	260,3	12,4	114,3	187	126,2	2,0	114,3	0,485	113,0	63,5		
14	Off	On	On	On	137,9	266,8	12,2	114,3	188	129,4	2,0	114,3	0,485	113,2	63,8		
15	On	On	On	On	175,8	334,4	12,1	115,6	169	167,3	1,9	115,6	0,500	114,5	62,3	62,3	

Figure 26: Example of measurement results from an EC to be used for derivation of a system curve for pumping station Ciceron in St. Lucia, Caribbean (2015) (source: CAH)

The system curve based on the measurement results can be easily obtained using Excel by plotting H over Q and inserting a polynomial trend line (order 2).

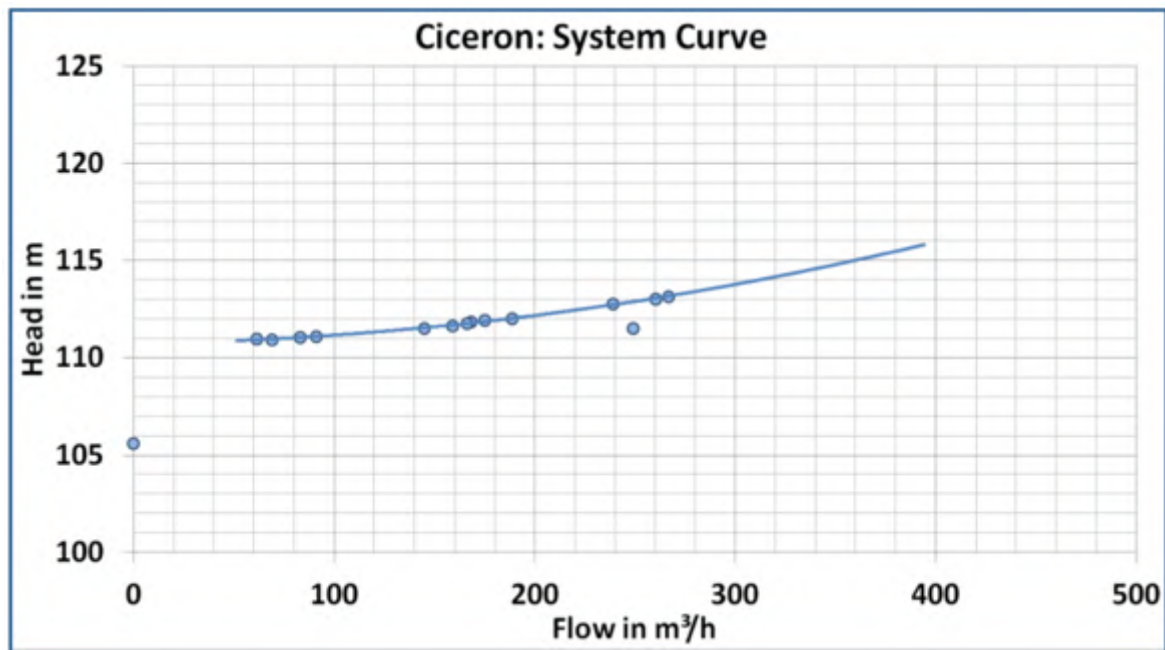
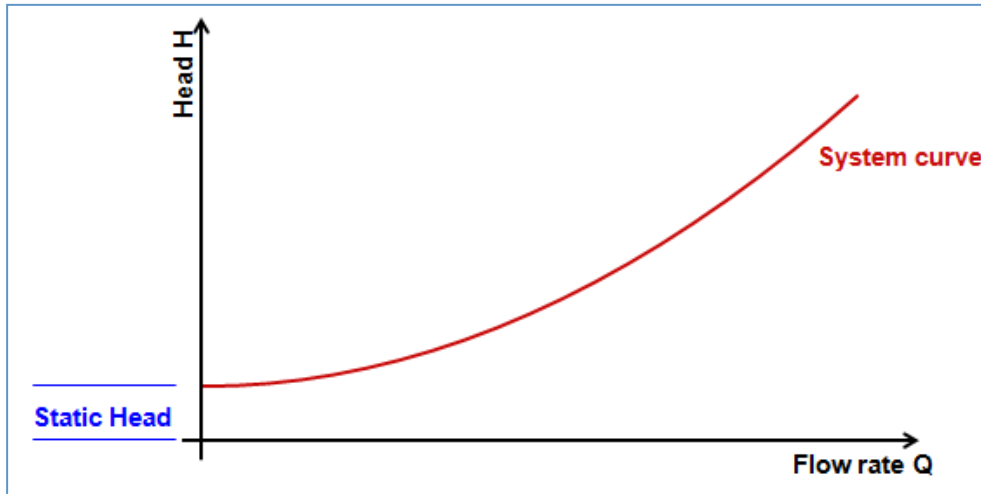

Figure 27: System curve for measurement results as shown in Figure 26 (CAH, 2015)





**Figure 28:** System curve (exemplarily) (source: HW 2015)

In the next step the pump curve is added to the system curve diagram. The pump operates at the operating point where the predetermined pump curve and the system curve cross each other, see Figure 29.

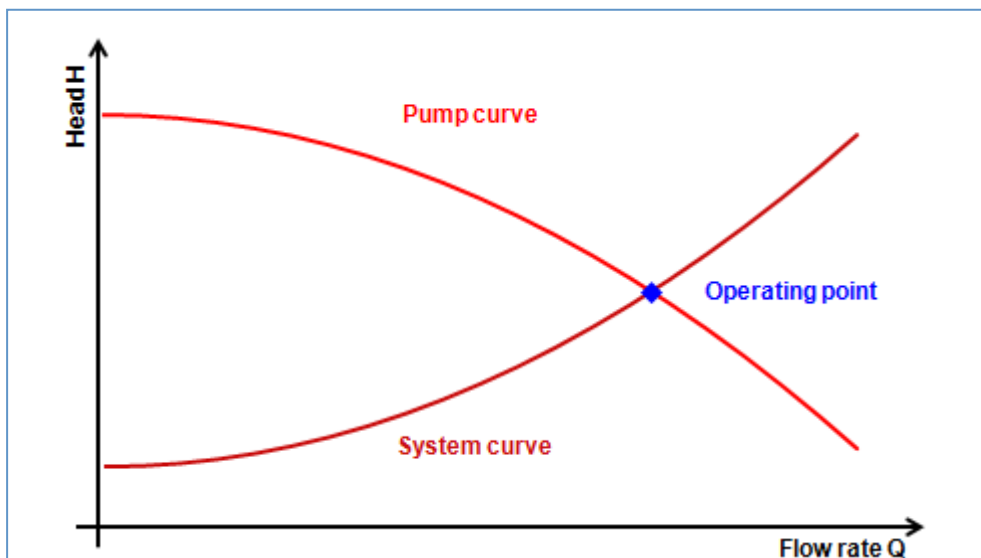

**Figure 29:** Determination of operating point (source: HW 2015)

The pump curves shifts depending on the electrical frequency. Thus, it is important to determine the actual electrical frequency set by the power company (or to measure the rpm of the pump) and to adjust the pump curve to represent the actual frequency/rpm.

In the next step the best efficiency point (BEP) has to be found, as pumps run most efficiently at this point. The BEP can be found in the documentation of the pump manufacturer. The BEP is located on the pump curve at its maximum efficiency. This is shown in Figure 30

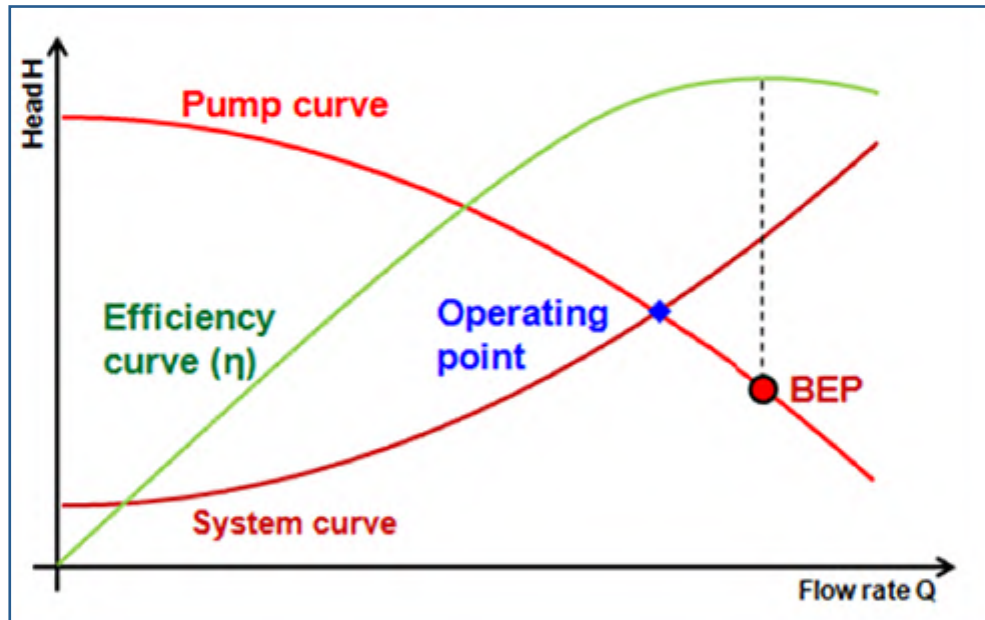

Figure 30: Best efficiency point (BEP) (source: HW 2015)

A pump should run within the area of best or better practice in relation to the BEP. The different operation areas for pumps can be summarized as follows:

Description	Area name	Relation to BEP <sup>7</sup>
Recommended operation condition	<b>Best practice</b>	-10% to +5% of BEP
Recommended operation condition (still improvement potential exists)	<b>Better practice</b>	-20% to +10% of BEP
Improve the operation to best or better practice, for limited (short) time periods operation in this range is okay (limited time)	<b>Good practice</b>	-30% to +15% of BEP
Avoid operation condition	<b>'Bad' practice</b>	Outside

Figure 31: Description of operation areas for pumps (own graphic)

In the yellow area of better practice (see Figure 32) additional losses can occur through discharge or suction recirculation. The red area should be avoided completely. Possible damages in this area can be: Seal damage, bearing damage, impeller damage, cavitation and motor damage. In general the pump runs only in a small area without getting damaged.

<sup>7</sup> The percentage refers to the optimal flow (BEP)

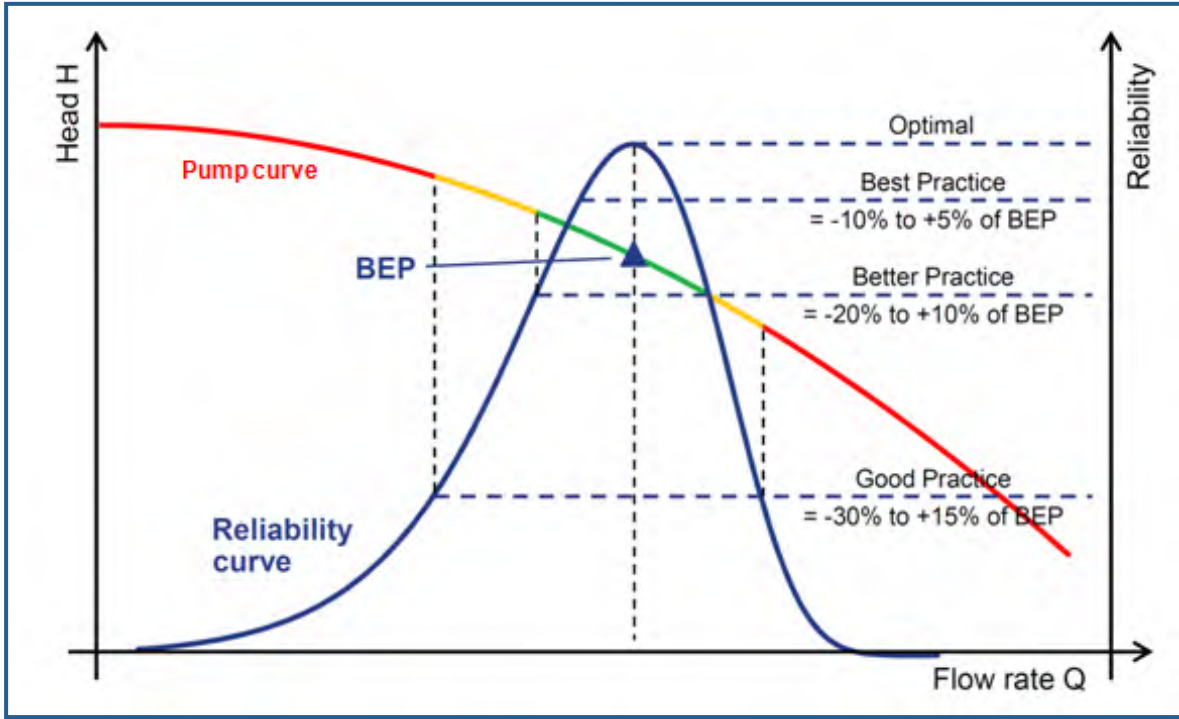

Figure 32: Operation areas of a pump (source: HW 2015)

Figure 33 shows the damages, which possibly occur to the pump parts if the pump is operated outside the better practice area.

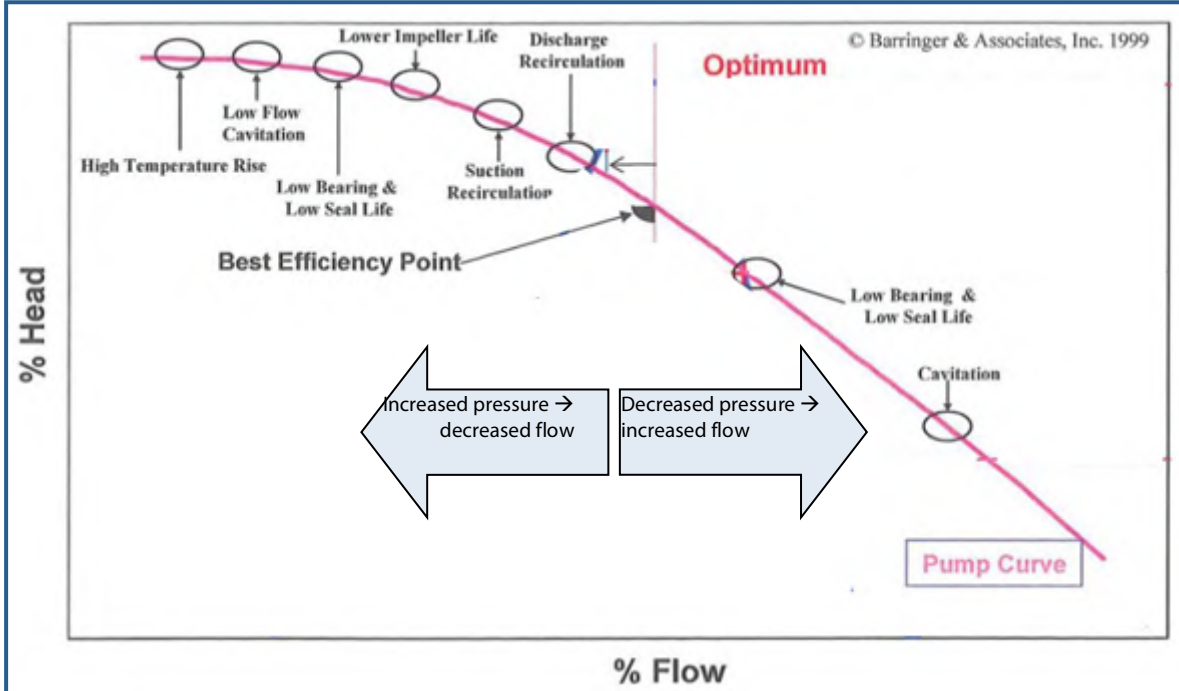

Figure 33: Failures at different pump areas (source: Barringer, 1999)

### Analysis of results and development of improvement measures

As shown in Figure 32 and Figure 33 the outcome of the system evaluation often shows that the pump is actually operated outside the better or even outside the good practice. This operation mode of pumps will diminish their life time, decrease the energy efficiency and cause additional operational failures. Therefore it is important to adjust the operation modes of the pump/PS according to the outcomes of the system evaluation.

In Figure 34 some initial measures to improve the operation of a pump that is operated out-side of the good practice are shown. The measures have been developed in a workshop (WS) with participants from a utility in the Caribbean. It is suggested to conduct a WS for the development of measures at this stage involving the operators of the PS. Often the operational personnel has good, efficient and easy-to-realize suggestions and improvement ideas. Furthermore the involvement of the staff at this stage increases their motivation and willingness to contribute later on in the implementation/realization of the EE-improvement measures.

Too high H too low Q	Too low H too high Q
<ul style="list-style-type: none"> <li>- Reduce number of pumps in operation</li> <li>- Minimize bends on the system</li> <li>- Ensure the suction way is free (<i>Are water intakes free of leaves or other material?</i>)</li> <li>- Ensure valves are fully open</li> <li>- Increase pipe sizes</li> <li>- Minimize leaks on the pipes on suction side</li> <li>- Check operation of no return valves</li> <li>- Increase water intake supply</li> </ul>	<ul style="list-style-type: none"> <li>- Throttling valve</li> <li>- Inspect pump for proper installation (impellers)</li> <li>- Check and fix leaks in discharge pipeline</li> <li>- Change pump</li> </ul>

**Figure 34:** Initial measures to improve pump operation

In Figure 35 the appearance of 'bad' system curves which cross the pump curve outside the good practice area is shown once again (area of best practice is not shown here). It is recommended for the EE-manager to create their own pump curves in which he/she displays the BEP and the areas of best, better and good practice in colours on the actual pump curve of the pump under assessment.

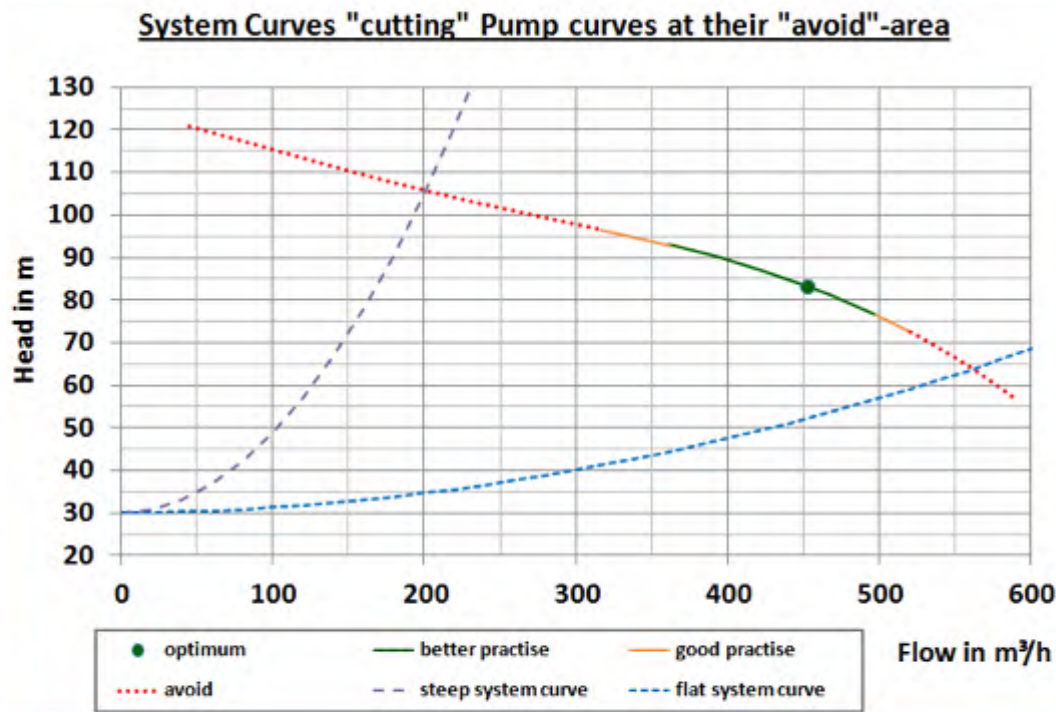

**Figure 35:** Visualization of 'bad' system curves (source: HW, 2015)

Other short- and medium/long-term measures to enhance the EE of pump stations are highlighted in Figure 36 below.

Short term measures	Medium/long-term measures
<ul style="list-style-type: none"> <li>- Pipe maintenance, ARV, CV, cleaning</li> <li>- Maintenance of pumps</li> <li>- Reduce/Enhance number of working pumps</li> <li>- Pump improvement (diameter) 'trimming'</li> <li>- Reduce friction losses (e.g. new coating for the pump casing see Figure 37)</li> <li>- Reduce number of pump stages</li> <li>- Check condition of casing and impellers</li> <li>- Create awareness amongst employees about good operation and EE</li> <li>- Check operation of valves and non-return valves</li> <li>- chose best pump combinations</li> </ul>	<ul style="list-style-type: none"> <li>- Change pipe size</li> <li>- Change pumps</li> <li>- Use variable frequency drive (VFD)</li> <li>- Minimize head losses of the system (bends, valves)</li> <li>- Reservoir construction (Tarification)</li> </ul>

**Figure 36:** Measures to enhance the EE of pumps and stations (developed by EE-TF members in 2015)



**Figure 37:** Newly painted pump casing (photo: Morocco, 2015)

First elements of a systematic approach for improvement measures are already part of the EA. The improvement measures shall be structured along the pump management life cycle as shown in Figure 38. The inspections and the exemplary improvement measures are explained in the 'Energy Audit based on Pump Life Cycle Management' in chapter 0.

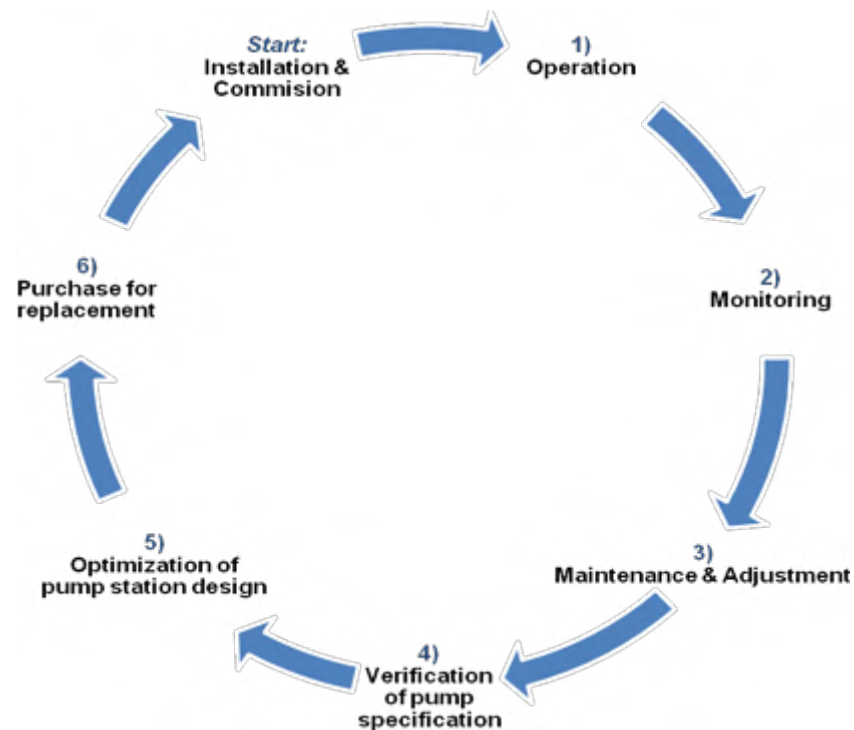

**Figure 38:** The pump life cycle management (graphic: HW, 2015)

## Financial evaluation implementation of selected EE measures

The final process to complete the EA is to evaluate which EE improvement measures are economically the most feasible. Last but not least the measures have to be implemented by drawing respective projects. These processes are described in Chapter 10 below in detail.

## 7.3 Energy analysis in wastewater treatment plants

### General comments – success factors

To conduct an energy analysis (EA) satisfactorily, the following success factors are essential. Some of them may seem trivial, but it is very helpful to observe them systematically.

1. **Baseline data quality:** Plausibility checks to verify the operational data as described in section 6.3 are extremely important. In particular, the BOD and COD load entering the WWTP must be confirmed, e.g. by comparing them with the other parameters (N and P) and the quantity of sludge produced (e.g. 1kg of BOD<sub>5</sub> equals ~ 1kg DM). Likewise, the annual operating hours for the machinery recorded by the operator should more or less tally with the operating mode (e.g. 8,000 - 8,760 hours per year for equipment in continuous operation).
2. **Accurate documentation of the circumstances during the period in question:** This documentation should include not only a list of the procedures and equipment installed but also an honest description of the operating mode (e.g. method of regulating aeration, any restrictions to operating hours due to lack of power, etc.) and the state of the electromechanical equipment (e.g. machinery that has broken down or is temporarily out of service). It is difficult to interpret the results for the KPIs correctly if the actual situation has not been properly described.
3. **Skills and experience of the experts conducting the EA:** The expert in charge of the energy analysis must not only be familiar with good practice in designing procedures, WWTPs and associated equipment, but must also have some experience of **operating** WWTPs.
4. **Set up a team:** Although it is beneficial to work with experts from outside the WWTP so as to gain an external perspective and obtain the necessary skills, the operator should always be included in the team conducting the energy analysis. He is the person most familiar with the procedures and the distinctive features of the plant, and he is the one who can provide the most valuable information on the WWTP's operating mode. As the energy analysis covers many technical areas, it is often useful to consult other experts for specific questions (hydraulic, electrical and mechanical systems, cogeneration, etc.).

### Description of stages of an energy analysis

An energy analysis (EA) consists of the seven stages shown in Figure 38 and subsequently described in detail. Stages three to five should be carried out iteratively because their results have an influence on each other.

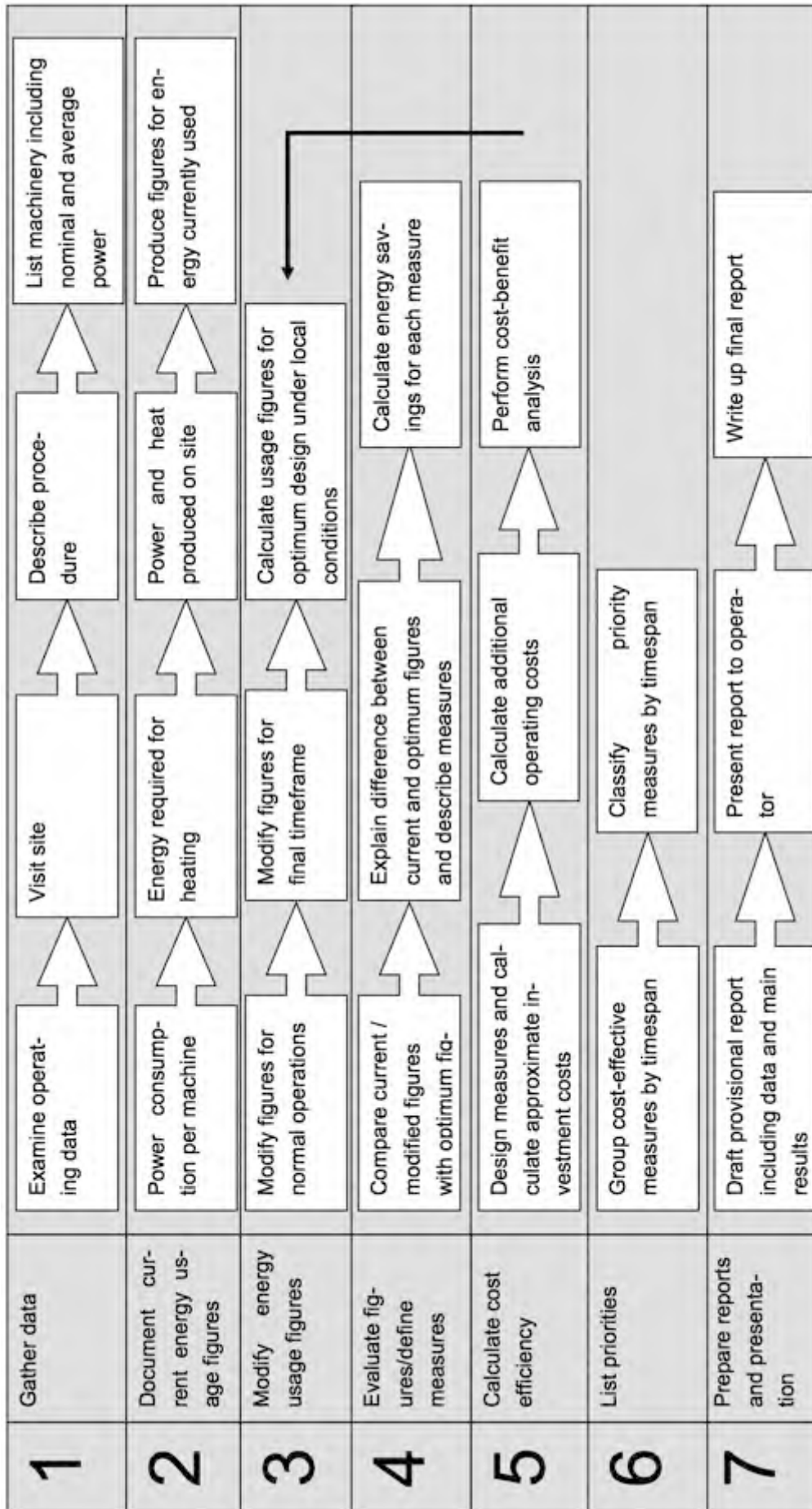

**Figure 39:** The stages in a WWTP energy analysis



## 1. Gather data

In principle, the WWTP operator should provide the EA team with all the operating data and an inventory of the plant and the electromechanical equipment including its main characteristics (electrical power, operating hours, effective capacity, flow, nominal pressure, etc.).

In fact, gathering data is usually an iterative process that begins with a first 'package' of information to focus the attention of the EA team. The team members then visit the site to verify the data they have received regarding the WWTP equipment and, with the operator, compile information on the current operating mode (automatic controls, any unserviceable equipment, special features of the wastewater being treated, etc.).

After critically appraising the data received and their on-site impressions, the team members will then, if necessary, carry out additional measures and analyses (e.g. analysing the wastewater to verify the load entering the WWTP, measuring the power for some major consumers). This baseline data is used to draw up:

- a detailed description of the procedures used and associated frameworks (e.g. threshold values to be observed, hydro-geographical peculiarities, the impact of industrial waste, etc.) and
- an inventory of the energy-consuming electromechanical equipment. The aim of this inventory is to itemise at least 90% of the WWTP's power consumption.

The description of the procedure and the equipment inventory should make it possible to establish overall energy usage figures for the WWTP, split into power consumption and heat flows (see Figure 40 and Figure 41).

## 2. Establish the WWTP's current energy figures

To obtain the overall figures for the WWTP, you start by calculating the annual power consumption for each part of the plant. This calculation is essentially based on the number of operating hours multiplied by the average power consumed by the machinery in question. If in doubt, it may be useful to measure the consumption of the equipment in question over several days. The results of the calculations are grouped according to requirements in order to identify the most important consumers and potential savings.

AGHIR WWTP		Electricity consumption calculations			
Location	Machine	Fraction operational	Fraction on standby	Annual operating hours [h/a]	Electricity consumption [kWh/a]
Degasification facility	Degasification blower	1	0	6,916	1,571
Degasification facility	Degasification blower	1	0	6,916	30,430
Screening station	Screen rake	2	0	728	291
	Conveyor belt	1	0	1,092	961
Grit and grease removal tank	Scraper bridge	1	0	5,824	9,318
	Grit classifier	1	0	3,276	472
	Grit removal tank blower	2	1	4,368	38,438
	Grit discharge pump	2	0	728	2,330
	Scum discharge pump	2	0	364	1,165
Aeration tank	blowers	9	0	1,820	380,380

**Figure 40:** Extract from the list of electromechanical equipment for a WWTP in Tunisia (Djerba Aghir)

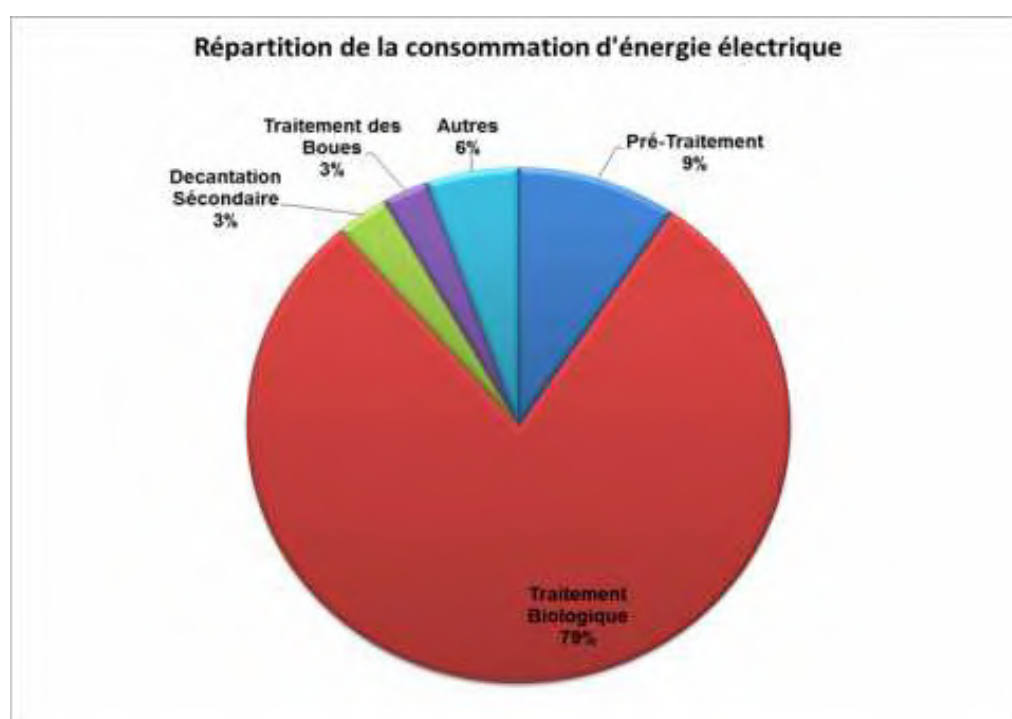

**Figure 41:** Breakdown of power consumption for a WWTP in Tunisia (Djerba Aghir)

The same calculation should be carried out for heating requirements if there is a sludge digester (digester heating) and/or heat-drying.

The power and heat requirements are then compared with the resources available, namely

- any power and heat produced on site (e.g. via cogeneration or solar panels),
- the power supply,
- the heat supply.

The usage figures also act as a plausibility check to verify the total amount of energy consumed by the WWTP.

## 1. Modify the WWTP's energy usage figures

### *Modify figures for normal operations*

Once the usage figures have been established for the actual conditions during the year in question, you need to ascertain whether there were any special conditions likely to affect the interpretation of the results. The temporary decommissioning of part of the plant or an exceptional variation in the treatment load could lead to the current figures being modified. This then gives you the 'theoretical consumption' under normal operating conditions. For example, for the aeration tanks you can calculate the oxygen requirements under normal conditions, and use that to deduce the energy requirements for the aerators. This approach can also be used to extrapolate results to cover the timescales of the study (e.g. for the design load of the WWTP, see Figure 42).

STEP Djerba Aghir		actuelle	théorique
Consommation électrique de la STEP, totale	kWh/a	905 588	1 274 463
Consommation électrique totale par EH(DCO90)	kWh / EH(DCO90) a	21	30
Consommation électrique totale par kgDBO5 éliminé	kWh / kg DBO5 éliminé	1.1	1.6

**Figure 42:** Actual and theoretical power consumption

These modified figures can then be used to calculate realistic savings under optimum conditions once optimisation measures have been implemented.

### *Modify the usage figures for optimum energy conditions*

To identify potential savings in energy and operating costs, the next step of the energy analysis is to calculate the minimum energy requirements of the major consumers. This calculation assumes that the facilities are designed and managed in line with good practice in order to achieve optimum energy efficiency, while at the same time taking account of local conditions that cannot reasonably be changed.

For example, if the location of the WWTP means that the wastewater needs additional pumping to reach the tanks, you need to accept the additional consumption for this pumping. However, it would be possible to replace a surface aerator with a fine bubble aeration system that was more energy-efficient. Obviously you then need to prove during steps four and five that the investment required for the new aeration system would be cost-effective within the timescales examined by the study. If it is not, you need to go back to step three to at least find a way of operating the surface aerators more efficiently.

So defining the optimum energy conditions is a process that is iterative and also somewhat subjective. But it will help you to identify possible savings, so that you can then find suitable optimisation measures. And the extent to which you will be able to identify cost-effective solutions to save as much energy as possible depends on the expertise and creativity of the technical advisor and the entire EA team.

#### 4. Evaluate energy usage figures and define optimisation measures

For every part of the plant where the optimum energy figures diverge significantly from the actual figures (either for the energy used or produced), you need to find explanations for these differences. If they are due to specific local conditions that cannot be changed, nothing can be done. If the difference is due to substandard design or poor operation, you need to define measures to improve the situation. These measures may involve modifying the WWTP's operating mode, partially or fully replacing an item of equipment or even changing the procedure used (e.g. using a digester rather than extended aeration to stabilise the sludge).

In the latter case you may need to wait until the WWTP is next upgraded to enable this modification to be implemented cost-effectively (this is referred to as a 'dependent' measure). But the EA can describe and quantify the investment costs involved as well as the resultant savings in operating costs. This will enable the operator and the funding agency to start seeking funding in order to implement the measure in due course.

#### 5. Calculate cost effectiveness

For any measures that appear worthwhile at first sight, you need to make an initial assessment of the work and equipment required, and draw up a rough estimate of the investment costs. By assuming a reasonable operating life for the new facilities, you can calculate the associated (annual) capital costs. Similarly, you need to calculate the energy savings and, if need be, the increase (or savings) in other operating costs. By documenting the additional costs and savings, you will be able to assess how cost-effective the measures will be (see also Section 10 Financial analysis).

Sometimes it may be useful to conduct a sensitivity analysis for any factors liable to sudden change, such as energy prices. In this case, you may be able to define the pricing conditions under which a measure will remain or become cost-effective.

Calculating the cost effectiveness will ultimately enable you to define the energy efficiency level the WWTP will be able to achieve with affordable funding.

## 6. Group measures according to priorities

Aside from the aspect of cost effectiveness, there are also often management constraints or limited investment resources, which mean that measures need to be prioritised. It may also be useful to group certain measures together because they affect the same equipment (e.g. if you need to empty the tanks) or because dependencies exist that call for measures to be implemented in a particular order (e.g. you need to construct a digester before reducing the capacity of the aeration tanks or the drying beds).

For this reason, at the end of the energy analysis you should suggest that priorities be established in line with the implementation timescales:

- priority measures to be implemented immediately (e.g. changes to operating mode, replacing probes, etc.)
- measures to be implemented in the short term that appear to be cost-effective but require some preparatory work, in terms of either planning or funding (e.g. replacing the aeration system)
- measures that are long-term or 'dependent' because they cannot be implemented in the short term, but may be worthwhile as part of a WWTP upgrade or renovation.

## 7. Reports

The energy analysis findings should be documented in a final report to enable management to pursue the proposed improvements and verify the effects of optimisation. It is therefore helpful for the reports to include details of the methodology used and the assumptions made when calculating the power consumption breakdown or any future energy savings.

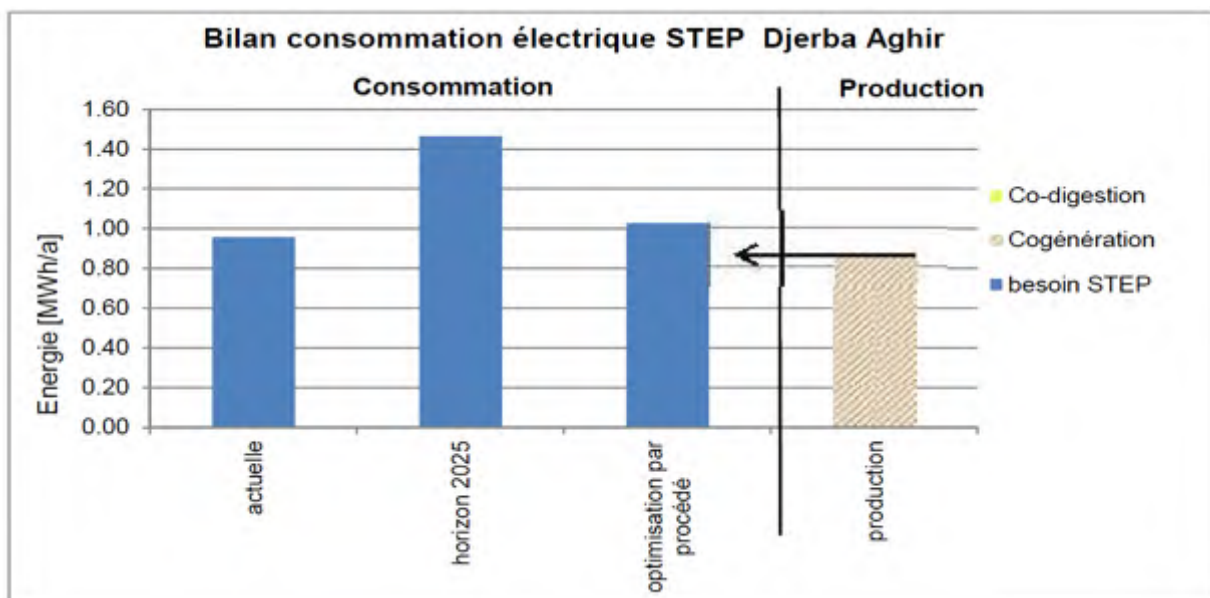

**Figure 43:** Energy usage figures with optimisation measures

Given that changing the operating mode of a WWTP and the way in which procedures are designed depends not only on energy consumption, it is highly recommended that you hold an initial presentation of your findings and optimisation ideas after step four. The findings regarding current energy usage and proposed optimisation measures often need to be modified as a result of comments or additional information provided by management.

In the final report, it is important to document the global energy usage figures, not only for current conditions but also post-optimisation, and sometimes also for interim stages (see Figure 43).

## 8. Step 5 - Energy Audit – the full view on all energy related aspects

Energy Audits in the context of water supply and wastewater treatment are a way towards a continuous improvement of the efficiency of the whole system. This means not only the evaluation of single components like pumps, but also includes the technical part as well as the organizational structure.

Starting an Energy Audit requires the intention of the top management to get a 360° view on their energy activities to later maybe enter into a process of continuous improvement.

The origin of the Energy Audit is the EN 16247-1 describing the Energy Audit process in general as a “systematic inspection and analysis of energy use and energy consumption of a site, building, system or organization with the objective of identifying energy flows and the potential for energy efficiency improvements and reporting them.” It is always done by independent experts, usually external ones. An option is to do it internally by an expert group, working directly under the top management.

An EAU is done by direct order of the top management, summarizing all results in a final report. It comprises recording similar data, developing the same KPI, analysing them technically and financially as needed for the EC and the EA. Therefore an (external/independent) EAU can build up on the results of an EC and/ or an EA, reducing the time allocation and thus the cost for external auditors (consulters).

An EAU evaluates the following elements:

- *total energy consumption and its frequency (EC, EA)*
- *building KPI to help analyse the data (EC, EA)*
- *deep analysis of the energy consumers (EA)*
- *load profiles of main consumers to better understand consumption details,*
- *maintenance programme and status of all installations*
- *further consumption associated aspects like:*
  - *organisational rules for operation*
  - *education status of the staff*
  - *existing procurement specifications and policies*
  - *organisational and financial responsibilities*

**Figure 44:** Elements of the EAU acc. to Lieback, 2015

Outcome of an EAU is a comprehensive report, describing the organisation in the view of dealing with energy aspects, the audit programme, the audit findings and especially the opportunities for energy efficiency improvements. Detailed recommendations for these are given from a technical, organisational and financial point of view.

Details of the realisation of an EAU are covered in detail by the European norm series 16247-1-5. No. 1 describes how to perform an Energy Audit in general. Details for special kind of energy use are covered in 16247-2 (buildings) 16247-3 (processes) and 16247-4 (transport). Finally 16247-5 lists competence criteria for energy auditors. The EAU is included here to give a general overview and to prevent confusion that often occurs in discussions because of different definitions.

### Energy Audit based on Pump Life Cycle Management

Before a water utility introduces an Energy Audit according to ISO 50001 the utility should undertake a self-evaluation of their pump life cycle management as shown in **Fehler! Verweisquelle konnte nicht gefunden werden..** Each step of the pump life cycle management (PLCM) contributes to the:

- Performance
- Durability
- Energy efficiency

of the pump.

Improvements within the different steps indicated in this cycle are the precondition for the performance improvement of pumps.

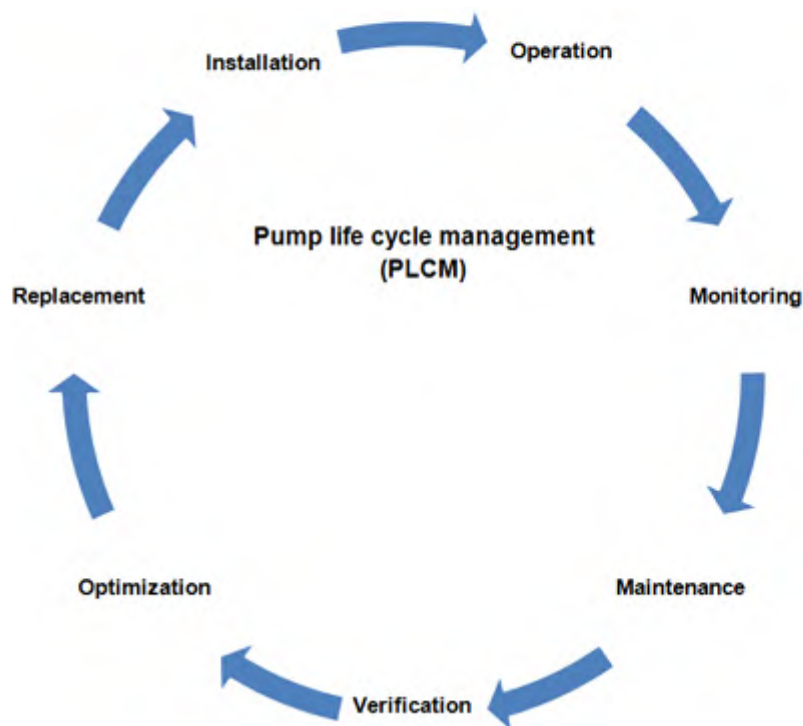

**Figure 45:** Pump live cycle management (graphic. HW, 2015)

Operation performance improvements could be achieved with training and motivation of the staff, while maintenance and optimisations first of all require the necessary budget.



**Note:** The application of the ISO (internally or externally audited) will only improve the data base of the performance of the pumps but not change the physical conditions at the site.

As an Energy Audit means entering into a cycle of continuous improvement, not only the technical aspects must be looked at, but the management structure in total has to be adapted. Therefore, while Figure 45 indicates the required steps to be undertaken in order to maintain pumps with high performance for a long period of time, it must be taken into account that this is only an example. The organisational structure should also be part of the cycle.

As shown in Figure 46 steps 1, 2 and 3 of the life cycle are usually undertaken but the required steps 4 to 6 are often totally neglected due to staff, maintenance and financial constraints.

<b>Pump life cycle management steps</b>		
<b>PLCM step</b>	<b>What has to be done?</b>	<b>Performance level utilities</b>
1) Operation 2) Monitoring 3) Maintenance	Follow-up and respect the operation conditions regularly through Energy Checks.  Maintain the pumps regularly (greasing, changing of bearings, complete overhauling etc.)	Usually undertaken
4) Verification 5) Optimization 6) Replacement	Verification and optimisation of pump specifications through Energy Analysis: Modification or replacement of pumps	Usually not undertaken

**Figure 46:** PLCM steps and usual performance patterns of utilities (source: HW, 2015)

Following the life cycle of a pump or a PS it is proposed to do the Energy Audit according to the following five inspection steps. The following description has been prepared to give indications to a EA-team to organise and manage the EA, but the list of activities related to each inspection might be further enhanced based on the specific water utility needs.

#### Exemplary Energy Audit based on Pump Life Cycle Management

##### Inspection 1: Operation and Monitoring

The first step of the inspection is the evaluation of the operation and monitoring. All data should be analysed and the PS should be inspected in detail to verify if all:

- equipment like pumps, valves, non-return valves is working
- all valves are open or throttled during operation and
- instrumentations (flow meters, pressure gauges, power meter etc.) are working

### Inspection 2: Verification and Optimisation

During the Energy Analysis it is very important to check if the hydraulic conditions have changed in order to operate the pumps at the designed duty point. The general reasons for a changed operation point of pumps (observed as a result of the EA) are:

- reduction in the yield of the wells
- changing of the hydraulic condition in the transport system
  - loss of head due to lower production and
  - increase of pressure due to deposits in the transmission line

These changes, which occur slowly over a long time are often not noticed by the engineers and will damage the pumps. For the verification and optimisation it is very important, that all original data from the manufacturer as well as all organisation and management information are available for the analyses.

### Inspection 3: Maintenance and Adjustment

The inspection of the workshops can give important information concerning the maintenance undertaken. The following questions have to be evaluated:

- Are the pumps regularly maintained and overhauled:
  - from a workshop from the water utility or
  - a private workshop
- Which parts are replaced:
  - only the mechanical parts or
  - also the hydraulic components like impellers
  - where do the spare parts come from (locally manufactured, original parts)
  - what is the quality of the spare parts
- Evaluation of the workshop:
  - staff and their qualification
  - facilities e.g. tool, spares, transportation etc.
- Evaluation of the performance achieved:
  - are performance tests undertaken after maintenance
  - are records of the maintenance kept in the relevant departments

### Inspection 4: Modification and or Replacement

During the annual Energy Analysis a detailed inspection has to be undertaken to verify the condition of the pumps and the PS. If required the pumps could be modified e.g. trimming of impellers or adding frequency regulations if the conditions have changed. Otherwise the pumps have to be replaced. This is already a good step forward to improve low performance of the existing pumps. The energy efficiency of the pumps can be improved only if regular funds are available for investments in:

- replacing pumps and accessories like valves,
- renewing the panels, instrumentations and gauges,
- automating the operation of these pumps also with frequency regulated drives

### Inspection 5: Evaluation of the Organisation and Management Structure

The setup of the organisation and management structure (O&M) plays a major role in the life cycle management of the PS. The O&M has to pass through different stages

- Energy Check: follow-up of the daily and monthly monitoring,
- Energy Analysis and Audit: carrying out annual EA, initiating maintenance if required and demanding replacement activities during budget preparations.
- For WWTP a fully conducted EA as described in Chapter 7.3 is very costly and time consuming. Therefore the annual repetition of an EA can be limited to the energy balance of main consumers and to the identification of repairs and maintenance needed to ensure best energy efficiency.

Afterwards the O&M has to start evaluating the whole process to improve the cycle for the next time.

In Figure 47 typical criteria for evaluating energy influencing factors are listed. Using these criteria in the evaluation process can be the basis to design an action plan for the further improvement of the utility.

Typical criteria for evaluating energy influencing factors
<ul style="list-style-type: none"> <li>- Consumption level</li> <li>- Extent of consumption fluctuation</li> <li>- Deviation from planned consumption</li> <li>- Cost effectiveness</li> <li>- Potential savings</li> <li>- Legal compliance</li> <li>- Extent of environmental impact</li> <li>- Time lapse to implementation</li> <li>- Possibility to influence consumption</li> <li>- Deviation from benchmarks</li> </ul>

**Figure 47:** Examples of energy influencing factors (source: HW, 2015)

## 9. Step 6 - Energy Management - starting a continuous improvement cycle

The final step in an energy efficiency improvement programme would be the implementation of an energy management system in a whole organisation. It asks the applicant to perform an Energy Review, analysing the energy use and consumption based on measurements and other data, identify the areas of significant energy use and finally to identify, prioritize, and record opportunities for improving energy. To analyse the data the applicant has to create "Energy Performance Indicators", like the KPI for EC, EA and the EAU.

Upon the results of an EAU an EnMS introduces a systematic improvement cycle that continuously helps to control the effectiveness and the efficiency of the whole system and its parts to improve the energy performance. This cycle is based on four elements called PDCA.

### Process of the PDCA-Cycle

- First the status is recorded in detail (EAU). This opens the opportunity to compare it with others or its own scale (benchmarking), to rate it and deduce objectives, targets and measures for improvement (PLAN).
- The control of the pursuit of this improvement plan and the systematic prosecution of energy measurements require an organisational frame and defined processes to follow in a systematically planned and controlled way (DO).
- Suitability of data recording, function of operational processes and achieving the goals demand a periodic systematic check-up (internal audit) if processes need to be improved and whether taken measures are adequate or need improvement (CHECK)
- As audit results demonstrate the status in relation to planned improvements they allow an evaluation of progress. The results of this review of the top management form the basis for strategy revision and the planning of new or changed goals and necessary measures. (ACT ► PLAN)

This is described in detail in the ISO 50001, its appendix and following numbers. It cannot be the subject of this guidance because the subject requires a guide on its own. Furthermore, in addition to the ISO-Norm a lot of international literature in all languages already exists, describing detailed approaches for all kind of organisations.

## 10. Step 7 - Financial Evaluation and Ranking

Based on the technical evaluation, whether it was undertaken under the EC, EA or EAU, the energy saving potential has to be specified in order to calculate the cost saving potential, e.g. energy costs per years (€/a). This cost saving potential has to be “compared” against the required investment cost necessary to gain this saving potential, e.g. modifications of the operation process, exchange of aeration system, modification of the PS or replacement of pumps etc. Normally investment in major energy consumers requires long term strategy decisions concerning the new specifications to cover future requirements in service levels e.g. flow, pressure, water quality standards etc. The decisions are normally undertaken according to the following 3 priority levels:

1. Long term investment measures e.g. expansion of the service area according to the town planning requirements often based on external requests from the municipality.
2. Investment required to guarantee the service level; replacement of damaged and broken equipment (pumps, panels, transformers, surface aerators, mixers etc.)
3. Improvements and optimisation of the internal processes e.g. energy saving measures, water quality improvements, control procedures etc.etc.

Due limited budgets, especially in developing countries, it is important that the management of a water utility is convinced to execute energy saving projects belonging to the 3rd category even if the financial benefit will only be gained after several years.

But due to the experience of executed EAU projects in water works, major energy efficiency improvements might only be cost efficient to justify larger investments if more than 20% efficiency improvements could be gained, e.g. for replacing of pumps. However in WWTP it is often possible to identify improvement measures on all levels with high financial benefit.

Therefore this Guideline recommends focusing on the first level in water works; but to consider also second and third level for WWTP. A major energy efficiency improvement could be achieved if all investments are undertaken under EE aspects:

- Analyse investment measures (1st and 2nd priority level)

For all investments the future operation cost and especially the energy consumption. Equipment like pumps should be selected with high performance and efficiency. Life cycle cost analyses should be made as a standard already for the planning and bid evaluation process.

- Analyse system optimisation (3rd priority level)

If investments are required or the service level could also be maintained if the existing system will be improved. In water utilities this can be for instance loss reduction in order to avoid the investment in new resources (wells, surface water treatment). No additional pumping is required by this measure! In WWTP this may be the installation or repair of oxygen-measuring tune/probe in activated sludge process or exchange of wheels in a pump..

## Methods for financial evaluation

For the financial evaluation the following two life cycle periods are used:

- *Technical life cycle* which can be 20 to 30 years for drinking water pumps and 10 to 20 years for equipment in WWTP
- *Financial life cycle* for pumps is normally calculated for 10 years, electrical equipment like panels for 20 years

In order to evaluate the cost saving potential against the required investment costs, the Net Present Value Method<sup>8</sup> (NPVM) could be used.<sup>9</sup> The following input parameters are required:

### 1. Calculation of the cost saving potential

The first step is the definition of the target efficiency e.g. for pumps, aerators or other equipment according to the specifications available on the market. Only energy consuming equipment with positive saving potentials should further be taken into consideration.

For water works the following criteria can be used for pumps:

- less than 80% efficiency in special cases like very large stations
- less than 70% efficiency for all other stations and wells.

In WWTP the following equipment is likely to have saving potentials:

- Aeration system
- Stirring devices
- Pumps

With this saving potential  $\Delta P$ , the annual operation time and the electricity tariff, the cost saving potential can be calculated.

### 2. Calculation of the required investment costs

The future specifications e.g.  $Q$  [m<sup>3</sup>/h] of the pumps or oxygenation capacity [kg O<sub>2</sub>/h] for the aeration tanks should be specified from the management of the utility according to their strategic planning.

For PS the annual pumped quantities divided by 365 days and 24 hours allows to get the discharge of the pumps (calculated  $Q_{2014}/365*24$ ) in order to calculate the **Rated Power (RP) in P (kW)**.

---

<sup>8</sup> Definition from Wikipedia: NPV can be described as the “difference amount” between the sums of discounted cash inflows and cash outflows. It compares the present value of money today to the present value of money in the future, taking inflation and returns into account.

<sup>9</sup> This calculation method is the standard at Hamburg Water.

For the investments of the new pumps, a peak factor for seasonal and spare capacities of 50% should be added if required:

$$[P_{\text{rating}}=Q \cdot h / (367 \cdot \eta) \cdot 1,5].$$

Specific Investment Costs (SIC) should be derived from executed projects, as a reference the calculation from the Jordan project is indicated in Figure 48:

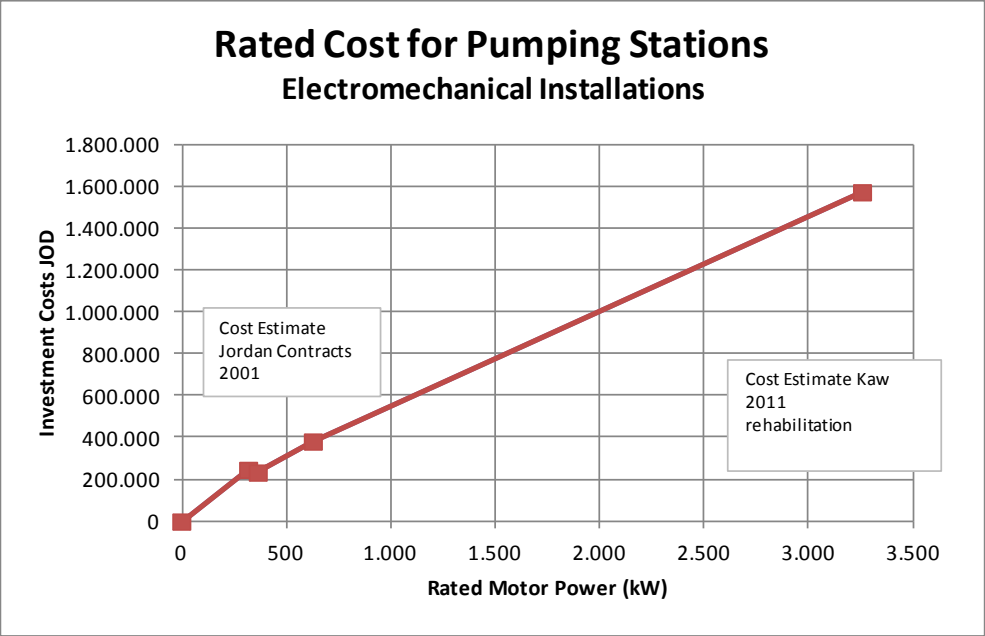

**Figure 48:** Investment Costs of the Rated Power (1 Jordan Dinar = 1,14238 €) (source, HW project in Jordan, 2001)

For WWTP it will be more delicate to establish investment cost by specific values, as the local conditions for extension or replacement of equipment are more complicated.

### 3. Cost/Benefit Analysis

For the calculation of the cost benefit analysis an Excel table was developed where the user fills in the required input data in order to calculate the savings of operation costs against the required investment costs.

This table is composed of the data input area, in the example case the comparison of:

- Option 1 without investment and
- Option 2 with investment in order to achieve the energy saving potential

Project Option 1 without investment				Project Option 2 with investment			
	Costs	Rising factor	Energy		Costs	Rising factor	Energy
	MAD	% p.a.	kWh		MAD	% p.a.	kWh
Investment	0			Investment	9,000,000		
discounted rate		0		discounted rate		0	
annual Maintenance p.a.	24000			annual Maintenance p.a.	8000		
Rising costs for Maintenance		3.0		Rising costs for Maintenance		3.0	
Initial Energy Costs	0.9			Initial Energy Costs	0.9		
Rising costs for Energy		4.0		Rising costs for Energy		4.0	
initial Energy Consumption p.a. ( $\eta=76\%$ )			21,374,400	initial Energy Consumption p.a. ( $\eta=82\%$ )			19,658,914
Wearing in Pump after 10 years extra maintenance	210,000			Wearing in Pump after 10 years extra maintenance	210,000		

The table contains the following input parameters:

- Financial evaluation period: 10 years
- Investment : 9 Mill MAD (11,8 MAD=1€)
- Discounted rate: 0%
- Annual maintenance: 24,000 for old pumps & 8,000 MAD for new pumps
- Rising maintenance cost: 3%
- Initial energy cost: 0.9 MAD/kWh
- Rising energy cost: 4 %
- Initial energy consumption: 21,4 Mill kW/a for old pumps with  $\eta=76\%$  & 19,7 Mill kWh/a for new pumps with  $\eta=82\%$

In Figure 49 the result of the cost evaluation is displayed.

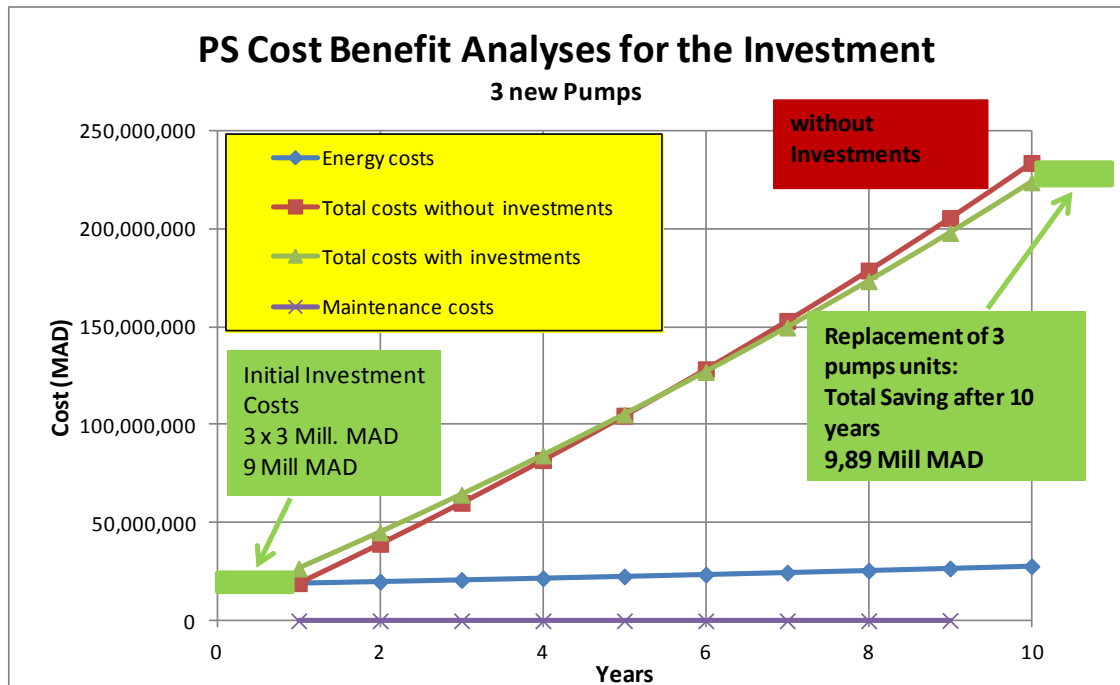

**Figure 49:** Cost benefit analyses Daourate TW PS (2015)

With the investment of 9 Mill MAD for 3 new pumps, about 9,89 Mill MAD could be saved af-ter 10 years. The blue line shows additionally the rising annual energy costs (from 19 to 27 Mill MAD) and the pink line at the bottom shows the annual maintenance costs which are negligible (24 to 30 TMAD with annually 3% cost rising for the old pumps).



#### 4. Conclusions of the Cost benefit analyses:

Even small losses in efficiency will justify the replacement of pumps due to the accumulated energy costs during the evaluation period of 10 years.

After 5 years the investment costs of 9 Mill MAD are already recovered through energy saved due to the higher efficiency of the new pumps (actually 76%, new pumps 82%) as shown in Figure 50.

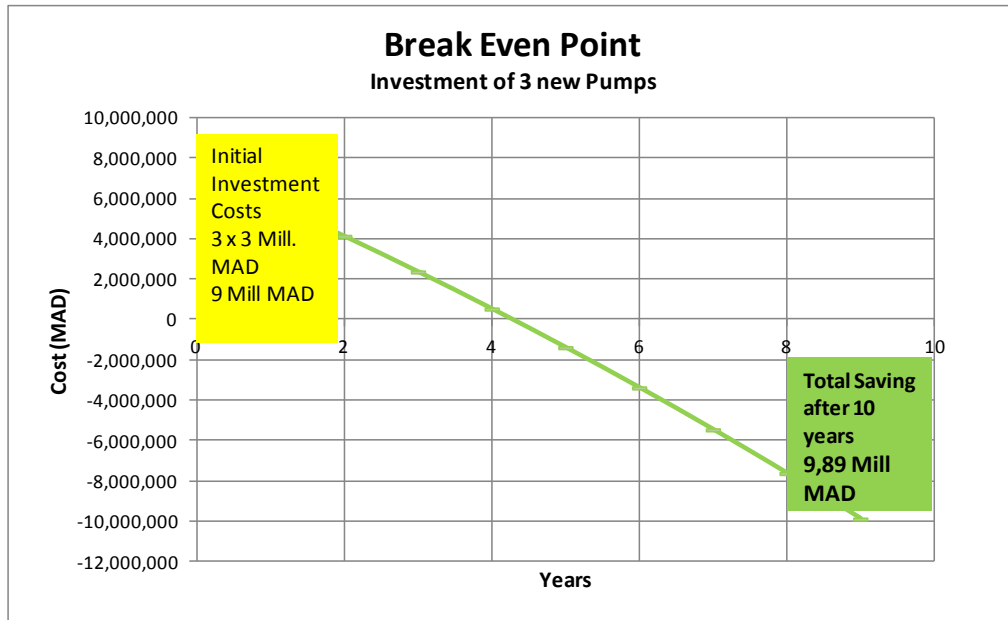

**Figure 50:** Financial evaluation Break Even Point Daourate TW PS (2015)

The detailed description of the NPWM is described in Module 1: Evaluation of Raw and Drinking Water Pumping Stations.

## 11. Step 8 - Reporting and Documentation

At the conclusion of the Energy Checks (EC), Energy Analysis (EA), Audits (EAU) and EnMS (Energy Management Systems) and any required follow-up data analysis, the respective results shall be reported in a written final report according to the steps undertaken (Samples are described in Model 1 and Model 2).

The report or any documentation delivered with the report shall include all data and technical and financial analyses so that the tasks undertaken can be confirmed by a third party, if required. This documentation shall be structured so it can be easily accessed by the management of the water company and other persons not involved in its development.

Before the report is finalized, members of the assessment teams shall review the assessment report for accuracy and completeness and provide comments. Upon review of the draft report and requests for modifications, the team shall provide a consensus acceptance, and then prepare and issue the report in final form.

The report shall contain the following information:

Chapter 1:

Introduction, content and goal information e.g. equipment data from the plates, manuals from the manufacturers, system maps and descriptions.

Chapter 2 EC:

Explanation of the test undertaken and description of the results of EC, compared with results from former EC.

Chapter 3 (EA):

Schematic description of the installations and their operations; system boundaries and parameters; list of aggregates with system, energy balance for electricity, based on the list of aggregates. Determination of energetic KPIs, comparing the existing conditions with optimum conditions. Description of improvement measures cost benefit analyses for proposed measures (saving operation costs against required investment costs), proposal for action plan.

Chapter 4 (EAU):

Cost Benefit analyses over 10 years and recommendations based on the technical evaluation, whether it was undertaken under the EC, EA or EAU, the energy saving potential has to be specified in order to calculate the cost saving potential e.g. energy costs per years (€/a). This cost saving potential has to be "compared" against the required investment cost necessary to gain this saving potential e.g. modifications of the operation process, modification of the PS or replacement of pumps etc. Normally investments in the major energy consumers requires long term strategy decisions concerning the new specifications to cover futures requirements in service levels e.g. flow, pressure, water quality standards etc.

The decisions are normally undertaken according to the following 3 priority levels:

- Short term measures: modifications of the operation conditions
- Medium term measures: modification of the equipment, maintenance and/or overhauling
- Long term measures: replacement of equipment e.g. pumps, pipes etc.

The reporting shall be based on the following regulations:

1. EN 16247-1 Energy Audits, Part 1 General requirements (2012) page 11 cont.
2. ISO/ASME144414:2015 (E): Pump system energy assessment, page 21 cont.

## 12. References

- 16247-1, D. E. Energy audits - Part 1: General requirements.
- EN ISO 50001, I. Energy management systems - Requirements with guidance for use.
- ISO/ASME144414:2015 (E): Pump system energy assessment.
- ACWUA. ACWUA Wiki. <http://www.acwua.org/>.
- DVGW and German Federal Environmental Foundation. (2010). Guideline energy efficiency and energy saving in water supply. Germany.
- DWA. (final 2015; draft 2013). DWA-A 216: Energy check and energy analysis – tools for energy optimization of waste water plants. Germany.
- Baumann, P., Roth, M. (2014). Reduction of electric consumption for waste water treatment plants. Stuttgart: DWA.
- GIZ and ACWUA 2014. Guidelines for Energy Checks and Energy Analysis in Water and Wastewater utilities. Version 1, Draft 2. Authors: Eric Gramlich and Markus Schröder. Tutthahs & Meyer Ingenieurgesellschaft, Germany. November 2014.
- Khaled Zaabar, SONEDE: Lignes directrices du plan stratégique de maîtrise d'énergie à la SONEDE 2012-2030, June 2015, Tunisie.
- Prof. Dr.-Ing. Lieback. (2015). Within 18 steps over 3 stages to Efficient Energy Management according to ISO 5001. Berlin: GUTcert GmbH.  
→ Free available under [www@gut-cert.de](http://www@gut-cert.de)
- VSA + Suisse energy: Energy in WWTP (« Energie dans les stations d'épuration »), Nov. 2008; [www.vsa.ch](http://www.vsa.ch)

ACWUA WANT programme website with further references and documents

<http://acwua-ee.mena-water.net/>

[www.mena-water.net](http://www.mena-water.net)

[www.acwua.org/training](http://www.acwua.org/training)

# 13. Annexes

**Annex 1: Pressure conversion table (source: HAMBURG WASSER)**

	bar	mbar	Pa (N/m <sup>2</sup> )	kPa (kN/m <sup>2</sup> )	Torr mmHg (0 °C)	mwc (4 °C)	at kp/cm <sup>2</sup>	inch Hg (0 °C)	inch H <sub>2</sub> O (4 °C)	PSI lb/inch <sup>2</sup>	atm
bar	1	1000	100000	100	750,062	10,1972	1,01972	29,53	401,463	14,5038	0,986923
mbar	0,001	1	100	0,1	0,750062	0,0101972	0,00101972	0,02953	0,401463	0,014504	0,000986923
Pa (N/m <sup>2</sup> )	0,00001	0,01	1	0,001	0,007501		1,01972 x 10 <sup>-5</sup>	0,0002953	0,004015	0,000145038	9,86923 x 10 <sup>6</sup>
kPa (kN/m <sup>2</sup> )	0,01	10	1000	1	7,501	0,10197	0,010197	0,2953	4,015	0,145038	0,00986923
Torr mmHg (0 °C)	0,00133322	1,33322	133,322	0,133322	1	0,0135951	0,00135951	0,03937	0,53524	0,019337	0,00131579
mWs (4 °C)	0,098067	98,0665	9806,65	9,80665	73,5559	1	0,1	2,8959	39,3701	1,42233	0,096784
at kp/cm <sup>2</sup>	0,980665	980,665	98066,5	98,0665	735,559	10	1	28,959	393,701	14,2233	0,967841
inch Hg (0 °C)	0,033864	33,8639	3386	3,386	25,4	0,345316	0,034532	1	13,5951	0,491154	0,033421
inch H <sub>2</sub> O (4 °C)	0,00249089	2,49089	249,089	0,249089	1,86832	0,0254	0,00254	0,073556	1	0,03613	0,002458
PSI lb/inch <sup>2</sup>	0,06895	68,9476	6894,76	6,89476	51,7149	0,70307	0,070307	2,03602	27,68	1	0,068046
atm	1,01325	1013,25	101325	101,325	760	10,3323	1,03323	29,921	406,78	14,6959	1

Annex 2: Derivation of the formula for KPI1 – overall efficiency (source: HAMBURG WASSER)

<p><b>overall efficiency:</b></p> $\eta = \frac{\rho \times g \times Q \times (H_d - H_s)}{P_{el}}$	<p><b>overall efficiency:</b></p> $\eta = \frac{Q \text{ [m}^3\text{/h]} \times H \text{ [m]}}{367 \times P_{el} \text{ [kW]}}$
---	---

$$\eta = \frac{\underbrace{\frac{998.2 \text{ kg}}{\text{m}^3} \times \frac{9.81 \text{ m}}{\text{s}^2} \times \frac{Q \text{ [m}^3\text{]}}{\text{[h]}} \times \frac{1 \text{ h}}{3600 \text{ s}} \times (H_d - H_s) \text{ [m]}}_{\substack{\text{for } 20^\circ\text{C} \\ \frac{\text{kg m}^5 \text{ h}}{\text{m}^3 \text{ s}^3 \text{ h}}}} \times \frac{[\text{s}^3]}{P_{el} \text{ [kg m}^2\text{]}} \times \frac{1000 \text{ W}}{1 \text{ kW}}}{1 \text{ W} = 1 \text{ kg m}^2 / \text{s}^3}$$

With  $\eta$  = overall efficiency = KPI1  
 $\rho$  = specific density of water at 20°C  
 $g$  = gravity = 9,81 m/s<sup>2</sup>  
 $H_s$  = pressure at suction side  
 $H_d$  = pressure at discharge side

## **Module 1: Evaluation of Raw and Drinking Water Pumping Stations**

(Prepared and tested with the assistance of SONEDE and ONEE TF-EE Teams)



(Participants of the Medinine Division SONEDE & Daourate ST ONEE)

**September 2015**

(Presented and approved from the EE Task Force at the Conference in Alexandria)

Prepared by Holger Laenge

**Prepared for the ACWUA TASK Force:** Energy Efficiency for application by members of the Arab Countries Water Utilities Association

**GIZ Program:** Strengthening the MENA Water Sector through Regional Networking and Training (ACWUA WANT)

**Task force name (TF EE):** Energy Efficiency in Water and Waste Water Utilities

**Target of the TF EE:** Instruments to enhance energy performance (efficiency, use, consumptions) are promoted amongst ACWUA members

Project manager of the GIZ:

Dr. Thomas Petermann, ACWUA WANT, GIZ Eschborn, Regional Department 3300

**Table of content**

- Preface..... 5**
- Introduction..... 6**
- Step 1: Identification of the Energy Saving Potential..... 7**
- Step 2: Identification of Major Energy Consumers..... 9**
- Step 3: Analyses through Key Performance Indicators..... 9**
- Step 4: Specification of the Investigation Levels..... 11**
  - 1 Energy Check (EC) ..... 11
  - 2 Energy Analyses (EA)..... 12
  - 3 Energy Audits (EAU)..... 14
- Step 5: Evaluation of the Pump Life Cycle Management ..... 14**
  - Inspection 1 Operation and Monitoring ..... 16
  - Inspection 2 Verification and Optimisation..... 16
  - Inspection 3 Maintenance and Adjustment..... 17
  - Inspection 4 Modification and or Replacement ..... 17
  - Inspection 5 Evaluation of the O&M Organisation..... 18
- Step 6: Financial Evaluation & Ranking ..... 19**
  - 6.1 Target efficiency for the Optimised Operation Conditions..... 19
  - 6.2 Calculation of the Required Investment Costs ..... 19
    - 6.2.1 *Rated Power* (RP)..... 19
    - 6.2.2 Calculation of the Rated Costs: ..... 19



## Abbreviations

ACWUA	Arab Countries Water Utilities Association
CAH	Consulaqua Hamburg
DCA	Direction Cote Atlantique
CED	Central Energy Department
DP	Desalination Plant
DS	Distributions systems
EA	Energy Analyses
EAU	Energy Audits
EC	Energy Checks
EED	Energy Efficiency Department
EMFM	Electromagnetic Flow Meters
GIS	Geographic Information System
GIZ	Gesellschaft für Internationale Zusammenarbeit Agency for international cooperation and development
GL	Guidelines
HW	Hamburg Wasser
JWU	Jerusalem Water Undertaking
KFW	Kreditanstalt für Wiederaufbau, German Bank for international cooperation and development
KPI	Key Performance Indicators
NRW	Non Revenue Water
ONEE	Office National de L'Eau et l'Electricité
OD	Operation Department
ODM	Operation Department Medinine
PI	Performance Indicator
PLCM	Pump Life Cycle Management
PS	Pumping Stations
SIC	Specific Investment Costs
SONEDE	Société Nationale d'Exploitation et de Distribution des Eaux
TF EE	Task Force Energy Efficiency
RW	Raw Water
SCADA	<u>S</u> upervisory <u>C</u> ontrol and <u>D</u> ata <u>A</u> cquisition
TS	Transmission system
TW	Treated Water
WF	Well Fields
WS	Work Shops (maintenance)
WU	Wastewater Utilities

## List of Tables

Table 1 Input table for the calculation of the cost saving potential .....	20
Table 2 Input data file for the Net Present Value comparison .....	21

## List of Figures

Figure 1: Pumps Life Cycles Management.....	6
Figure 2: Organization of the waterworks facility .....	8
Figure 3: System Components of the PS.....	9
Figure 4: BEP, Duty point and Operation point.....	12
Figure 5: Pump performance evaluation.....	13
Figure 6 Life cycle cost for a pump (HW data).....	15
Figure 7 Pump performance evaluation (life cycle).....	16
Figure 8 Institutional set up of PLCM .....	18
Figure 9 Investment Costs of the Rated Power .....	19
Figure 10 Cost benefit analyses Daourate TW PS.....	21
Figure 11 Financial evaluation <i>Break Even Point</i> .....	22
Figure 12 Billed amount (STEG) and the cost saving potential SE Tunisia .....	22

## List of Annexes

Annex 1 Location Map of Water Direction Cote Atlantique (ONNE).....	24
Annex 2 Evaluation of the Operation and Maintenance Budget of a water utility.....	25
Annex 3 Ranking of PS Operation Department Medinine .....	26
Annex 4 Evaluation Table for Pump Test (Model Morocco ONEE) .....	27
Annex 5 Data Evaluation Sheet from the EA Jordan .....	28
Annex 6 Life cycle costs of a pump .....	29

## Preface

This module was developed in cooperation with the Energy Efficiency Departments (EED) of SONEDE and ONEE in order to test the Guidelines<sup>1</sup> prepared during the project implementation. Both teams from Morocco and Tunisia were trained on the application of the GL during the training in Morocco (24-28.11.2014). The first testing phase was undertaken in Tunisia (16 to 28.02.2015); the second in Morocco (16 to 28.03.2015).

The main objective of the GIZ project is:

- to develop Instruments to enhance energy performance efficiency (efficiency, use, consumption) and
- promote them amongst ACWUA members.

This Module 1: Evaluation of Raw and Drinking Water Pumping Stations was developed to provide application recommendations of an Energy Check/Analysis. It is based on the experience of the consultant gained for a countrywide Energy Audit executed in Jordan in 2012/13 financed from GIZ<sup>2</sup> & KfW<sup>3</sup>.

### Activities undertaken

In order to evaluate the already existing practice of the EC & EA, the adviser collected the existing reports and documents from the different sections of SONEDE & ONNE from Operation & Maintenance Departments (O&MD) and studied their working procedures and applications. The energy measurements were undertaken from the concerned O&M teams. SONEDE has a central Energy Division (*Direction de La Maîtrise de l'Energie, Direction Centrale des Études*), which have executed the measurements. At both countries the maintenance facilities were visited.

This guideline will outline the important steps to be undertaken; reference is also made to the Mission reports from Tunisia and Morocco. These reports are examples of EC & EA undertaken under the ACWUA GL.

---

<sup>1</sup> Guidelines for Energy Checks and Energy Analysis in Water and Wastewater Utilities, Main authors: Eric Gramlich, M.Sc., Prof. Dr.-Ing. Markus Schröder Tuttahs & Meyer Ingenieurgesellschaft, Germany Members of DWA and German Water Partnership GWP, November 2014, Draft 2 English version

<sup>2</sup> giz: Energy Efficiency Programme (EEP), Energy assessment in the Jordan Water Supply Systems

<sup>3</sup> Kreditanstalt für Wiederaufbau, German Bank for international cooperation and development

## Introduction

In drinking water utilities the pumping stations (PS) are the mayor energy consumers. The major saving potential can normally be located within the pumping units; therefore profound knowledge of the *pump and the attached motor* is required (hydraulic, electrometrical and material knowledge).

➔ This work should be undertaken normally from (*electro-*) *mechanical engineers* with the above mentioned qualifications. Operation engineers might have the qualifications but normally do not have the time to undertake the EA in detail!

The energy consumption of the treatment facilities like mixers, back wash water pumps and blowers are normally of secondary nature. The inspection of the electromechanical equipment within the water treatment process will be done in view of process optimisation aspects in order to maintain WHO standards rather than under energy efficiency considerations.

*Material management of pumps is a complete cycle* as it is shown in Figure 1 starting with the procurement & installation, the pumps & motors will be operated, maintained and later also inspected if the design specifications are still complying with the operation conditions and eventually the system has to be optimised. Only if this complete Pump Life Cycle Management (PLCM) is well maintained, the pumping unit will work with high efficiency over a long period.

*Energy checks/analysis/ audits are tools to monitor* the working conditions and *assist to analyse deviations* from the designed specifications or damages of the mechanical parts. But these inspections will never improve the situation without interventions like maintenance/optimisation and/or replacements. Therefore, the required budget must be allocated in time and at the right place; otherwise the budget is spent for high electricity costs due to the low efficiency of the pumps in operation and not on the improvement of the O&M conditions!

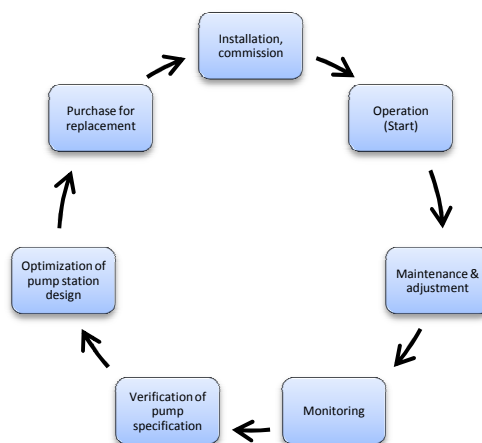

Figure 1: Pumps Life Cycles Management

This module was developed in order to evaluate the energy consumption of the PS in connection with the primary transmission system (TS). The primary TS is pressurized from these PSs, therefore the evaluation of the system can also contribute to major energy reduction. But the investments in the optimisation of the TS e.g. changing of pipes etc. is normally much higher, therefore the optimisation of the PS is generally done with shorter

pay-back periods and shows quicker benefits in service improvements (flow & pressure) and results in energy reduction. The optimisation of the TS is normally done under strategic aspects (long term planning) for future demand considerations (population growth etc.). Regularly performance checks & analysis of the TS and distribution systems (DS) are not common.

The aim of this module is to guide the user passing through the indicated individual steps. All required procedures as well as calculation methods including the relevant input tables are presented in the module. All users are invited to update the draft module in order to improve and share the experience in the operation of energy efficient water supply management.

According to the experience of the consultant, energy saving measure in the drinking water sector can not be generalised. The following **aspects** have to be taken into consideration:

- 1) Special *national legal procedures* for the utilities are playing an important role
- 2) The electricity tariff is an important factor, if investment measures might be cost effective
- 3) The Pump Life Cycle Management (PLCM) (procurement, O&M and optimisation) is an important tool to keep the equipment in good operation condition with high performance efficiency
- 4) Last but not least staff availability and qualifications to follow and execute the PLCM
- 5) Availability of the private sector for supply, operation and maintenance assistance.

Every team has to find its own strategy and measures to apply their individual energy saving strategy.

### Step 1: Identification of the Energy Saving Potential

The components and the area to be included into the Energy Checks & Analyses must be defined e.g.:

- Submersible pumps in well,
- raw water pumping station and
- treated water pumping station pumping into transmission or distribution systems

The following Figure 2 shows the component of the drinking water infrastructure:

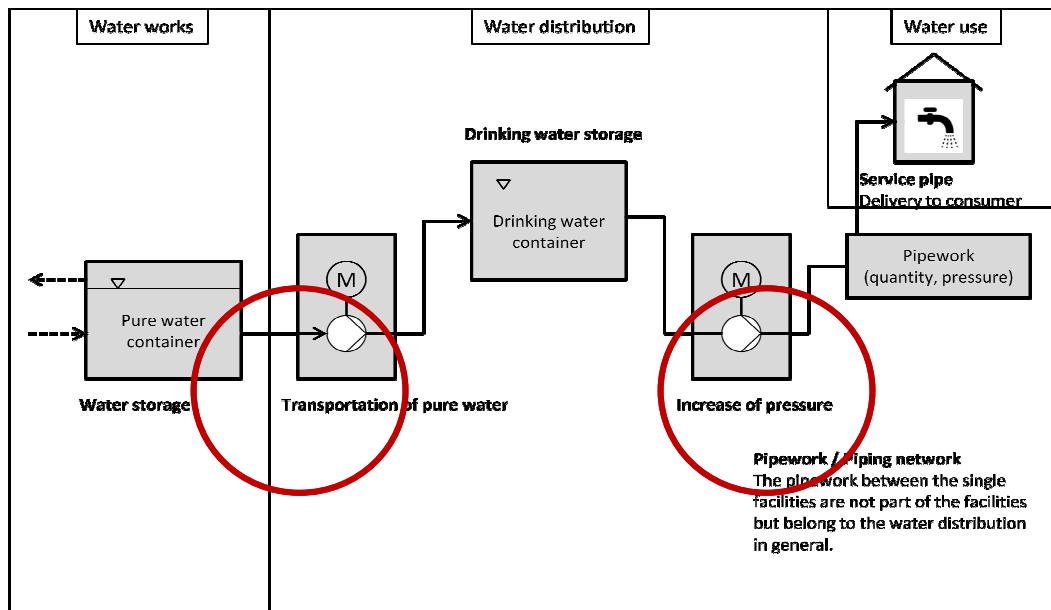

Figure 2: Organization of the waterworks facility.

(Red circles show the pumps to be included into the EC & EA)

The boundaries and the system facilities should be displayed in a Geographic Information System (GIS) base map attached with the relevant system data for all relevant components (e.g. information concerning: PS & TS, material, elevations, operation & maintenance etc. See Annex 1 Location Map of Water Direction Cote Atlantique (ONNE)).

Initially the importance of the energy consumption as part of the operation budget has to be analysed. The data are normally available within the Accounting Department (annual profit and loss statement). In Annex 2 (for Aleppo, Syria & Jerusalem Water Undertaking (JWU)) the different cost centres are displayed in order to evaluate the overall energy saving potential and the relevance to introduce energy saving measures:

Concerning energy saving measures, the water infrastructure can generally be divided into the following 3 categories:

**1 High Energy Saving Potential**

E.g. Aleppo Water Establishment has a relative huge budget for electricity of about 30%, since the water is pumped from Euphrates to Aleppo City over 90 km, the water is further distributed to the city and supplied to the whole province; Aleppo Water Establishment should have a high focus on energy saving measures. But the electricity bills were paid in 2009 from the central government in Damascus; therefore the Establishment has had no interest to invest in energy saving measures. Reference is made to the list above: Aspect 1 Special national legal procedures for the utilities are playing an important role.

**2 Medium/Low Energy Saving Potential**

E.g. Jerusalem Water Undertaking (JWU) spends only 9% for electricity due to the large amount of imported water from Israel for which it spends about 45% of its budget. The imported water is injected already at a good location with a certain pressure. Therefore JWU has its focus on loss reduction (26% NRW in 2014) in order not to waste the expensive imported water.

### 3 No Energy Saving Potential

Gravity systems have hardly any energy saving potentials, but often use turbines to generate electricity from excessive pressure (e.g. Aquaba in Jordan)

## Step 2: Identification of Major Energy Consumers

Once the needs for energy saving measure are agreed from the management, the major energy consumers have to be identified and ranked. In Morocco in the selected project area “Direction Cote Atlantique” only 2 facilities are consuming 96% of the energy; the selected production station Daourate is the largest energy consumer with 48%.

While in Morocco only 2 stations are in the selected area, in Tunisia<sup>4</sup> “Operation Department Médenine” many smaller stations are located. Therefore these stations have to be ranked according to their energy consumption and efficiency (global annually efficiency – for details see Annex 3). The first data evaluation gives already a good overview for the major energy consumer and their relevant saving potential. The investigations in Tunisia were started with the major energy consumers e.g. Zeuss and Arram PS.

## Step 3: Analyses through Key Performance Indicators

Figure 3 displays the components of the pumping unit:

- Pump
- Motor
- Frequency regulation (if available)

The major saving potential can be normally identified in the **pump performance**. New and eventually better specified motors with higher performance might contribute to the energy savings, but only to change the motors due to this reason if often not economic.

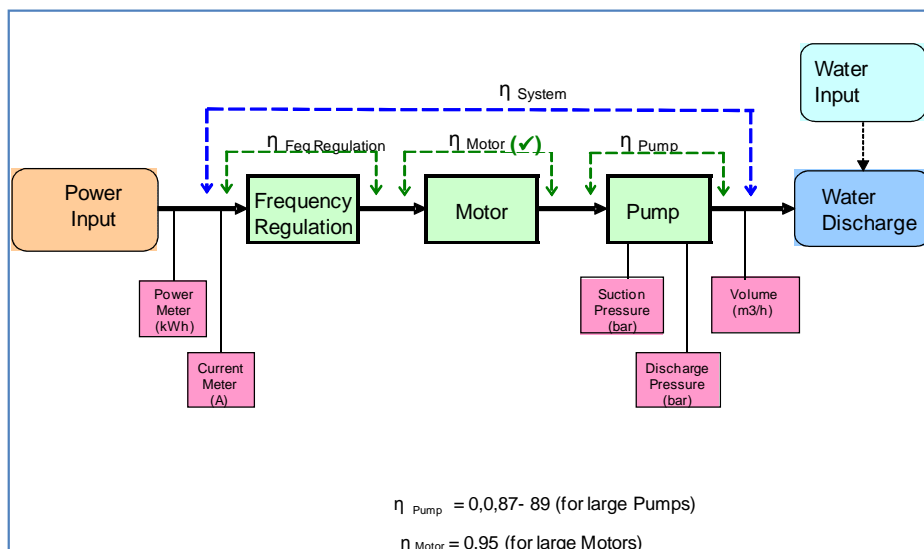

Figure 3: System Components of the PS

<sup>4</sup> Rapport de Maitrise d'Énergie Direction Centrale de Production, Direction Territoriale de Production Sud Est, Division de Production Médenine

The performance of a PS can be analysed with the following system parameters:

- Input parameters (Electrical power): power (kW), Current (A), Tension (V),
- Output parameters (hydraulic power): flow (m<sup>3</sup>/h or l/s), pressure (bar or mh)

The following three hierarchic levels of controls are normally applied in water utilities:

- 1<sup>st</sup> level: Control of the *service parameters*:  
flow (l/s), pressure (HMT) and water quality  
(guarantee of the service to the customers)
- 2<sup>nd</sup> level: Control concerning the *compliance of the electricity tariff (STEG)*:  
to avoid penalties (cos φ, max power)
- 3<sup>rd</sup> level: PS performance control  
Control of the energy efficiency & consumption (η, kWh, kW/m<sup>3</sup>)

The frequency of the control will be discussed in the next section (energy checks, analysis & audits).

According to the experience of the Consultant, the following three Key-Performance Indicators (KPI) are important to control the energy consumption for existing PS:

### **KPI 1 Overall efficiency of pump & motor**

$$\eta = \frac{\text{Hydraulic Energy (output)}}{\text{Electric Energy (input)}} = \frac{P_{\text{pump}}}{P_{\text{el}}} = \frac{Q \cdot H \cdot \rho \cdot g}{\sqrt{3} \cdot U \cdot I \cdot \cos \varphi}$$

- electricity consumption (P: kW) measured by tension (Volt) & current (Ampere)
- respective pumped quantities (Q) measured m<sup>3</sup>/h or l/s
- required head (H:m) measured m or bar with a manometer
- for wells: dynamic water level in order to calculate the total head

### **KPI 2 Specific energy consumption (per meter head pumped)**

$$\rho = (P/Q \cdot h) \quad (\text{kWh/m}^3 \cdot \text{h})$$

### **KPI 3 Specific Energy consumption**

$$\rho = (P/Q) \quad (\text{kWh/m}^3)$$

These KPI can be used to analyse a

- whole pumping stations in order to get an overview or for
- individual pumps in order to identify saving potentials

It is recommended to start with groups of power consumers like:

- well fields and
- pumping stations

In a first step the facilities with the largest saving potential can be further analysed in detail. In a second approach the energy consumers can be ranked according to their saving potentials.



## Step 4: Specification of the Investigation Levels

The guidelines already specified the following 3 levels of investigations:

1. Energy checks (EC)
2. Energy Analysis (EA)
3. Energy Audit (EAU)

These levels will be specified in order to give further guidance to the working teams:

### 1 Energy Check (EC)

Energy checks are part of the regular operation process control (hourly, daily and monthly):

1. At least all pumps have Ampere meters which indicates the energy consumption ( $P=\sqrt{3} * U * I \cos \varphi$ )
2. Modern pumping stations have flow, pressure (suction & discharge) and power measurements (tension, current, power etc.) which are also part of the process control and monitoring system (SCADA) with alarms.

These data are registered either

- manually by operators in logbooks or
- with SCADA system (digital data records)

Preconditions for regular Energy Checks is the availability of the *Instrumentation & measuring equipment*:

 **Maintenance or replacement of faulty instruments e.g. manometers, flow & ampere meters, check valves etc. is the first precondition of regular EC!**

### Instrumentation

Flow meters: Electromagnetic Flow Meters (EMFM) are recommended,  
Pressure gauges (suction & discharge):  
Manometers for smaller PS ,  
electronic pressure sensors are more reliable and precise for larger PS

Power: Ampere meter for each pump for smaller PS  
Power meters for each pump for larger PS

*Generation of KPI:* The following above mentioned KPI should be included in the daily reports with the relevant margin (values for max, min), so that the EC can be done daily as part of the operation control by the operators and engineers:

- KPI 1 overall efficiency (%)
- KPI 3 specific energy consumption (kW/m<sup>3</sup>).

Generating of these KPIs is already the precondition to monitor the power consumption.

Decrease of the KPI 1 (efficiency) or the KPI 3 (specific energy consumption) is already a clear sign of a

- deviation of the operation condition from the designed specifications and/or
- damage of the pump/motor

and requires immediate inspection and maintenance before the pump might be damaged or a break down occurs.

## 2 Energy Analyses (EA)

All data generated by the regular EC will be further used for the 2<sup>rd</sup> level. The EA requires a complete evaluation of the individual PS including their TSs, in order to verify their designed specifications versus the actual operation conditions.

For the evaluation of the pumps, the following KPI are proposed:

- KPI 1 overall efficiency (%)
- KPI 2 specific energy consumption (kW/m<sup>3</sup>\*m).

In Annex 4 the table for testing of pumps is attached (ONEE model). Single point testing was applied due to the existing operation conditions with very high geodetic level difference and very low friction losses. This table is recommended for large PS, for smaller stations a simplified table can be used.

KPI 3 is not specific and therefore **not relevant** for the EA since the power consumption is depending on the pressure:

- KPI 3 specific energy consumption (kW/m<sup>3</sup>)

The following *annual* data collection and data verification is recommended:

- Collecting all system information e.g. lay out of the station, data sheets of all facilities like pumps, valves, measurements etc.
- Checking of exiting operation data for accuracy by installing reference measurements (ultrasonic flow meter, electronic pressure gauges and a power analyser)
- eventually more detailed measurements have to be undertaken:
  - if it is possible to measure for each pump/well several operation points (4 points),
  - generate the Q-h curves of the existing pumps and
  - compare with the original pumping tests curves

Figure 4 shows the specification of a pump:

- the light red line shows the original Q-H curve of the pump,
- the dark red line shows the system curve (e.g. transmission system)
- pump and system curves match at the operating point

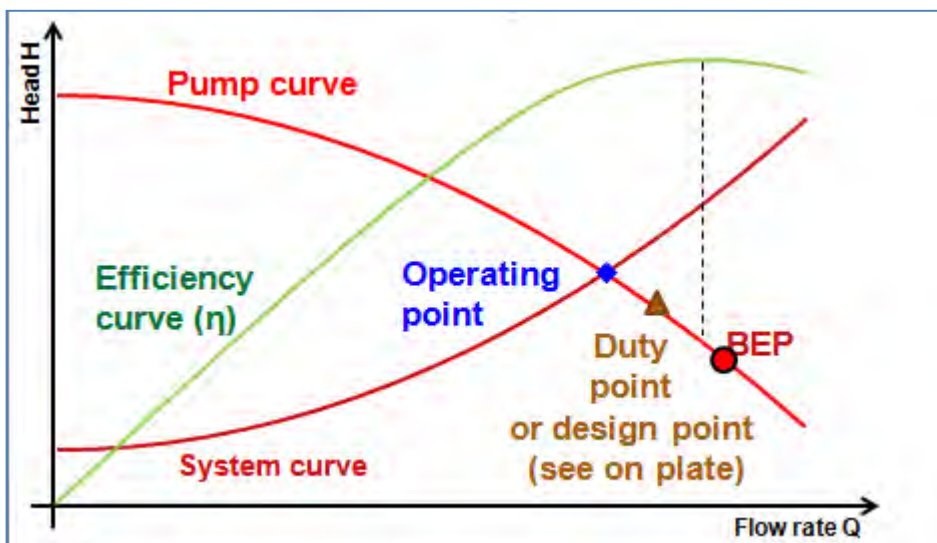

Figure 4: BEP, Duty point and Operation point

➔ The verification of the *design specifications against the actual operation conditions* are the most important tasks of the EA.

KPI 1 (pump and motor efficiency) is the **most important** parameter. Measurements can be compared with the original data provided from the data sheets of the manufacturer. These data sheets were part of the original contract. It has to be verified that the pumps are still working within the area of the Best Practice (Better Practice for shorter periods) in order to guarantee a long life cycle with high efficiency. Figure 5 summarises the recommended operation conditions provided from ANSI<sup>5</sup>:

- recommended operation condition: best practice -10% to +5%
- for short periods only (limited time): better practice -20% to +10%
- avoid operation condition: good practice -30% to +15%

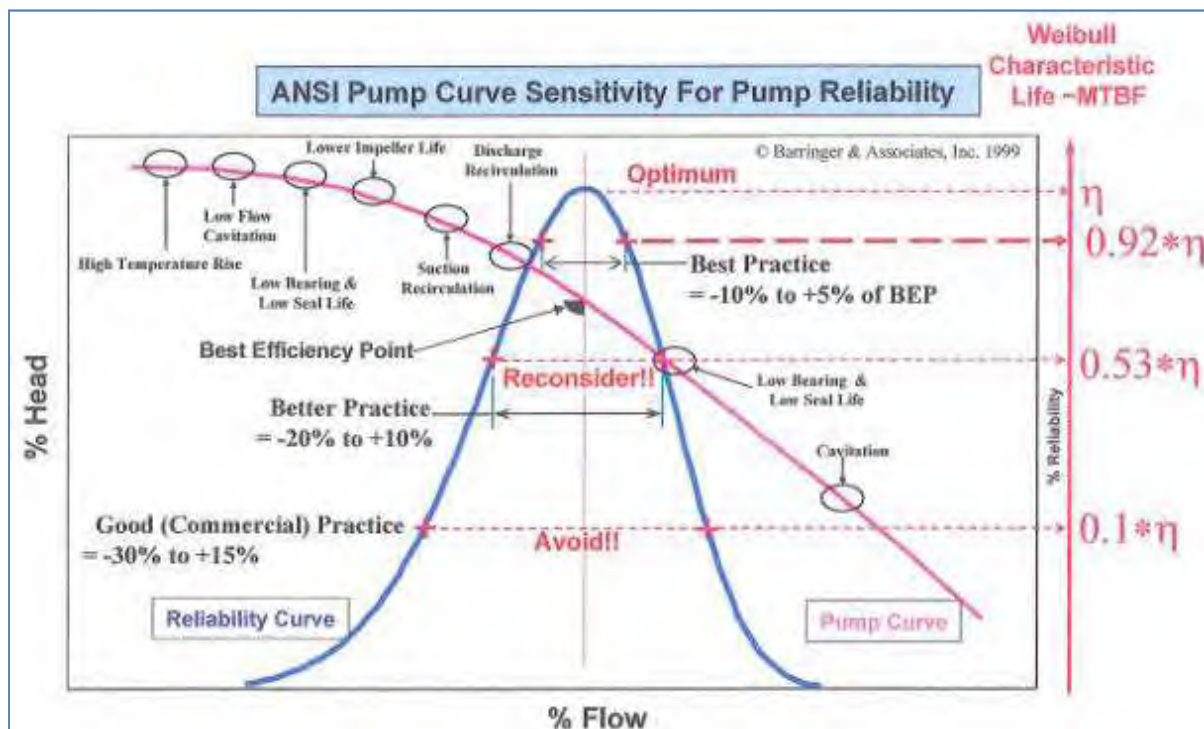

Figure 5: Pump performance evaluation

The presented diagram also shows the damages which will occur to the pumps parts, if these conditions are not respected:

- decreased pressure ➔ resulting in increased flow:
  - cavitation,
  - low bearing and seal life
- increased pressure ➔ resulting in decreased flow
  - low impeller life,
  - discharge recirculation,
  - low flow cavitation,
  - low bearing and seal life

Also KPI 2 is a reference for the performance of the PS or the individual pump, the specific value should be below 4 W/(m<sup>3</sup>\*m) indicating good efficiency above 70%.

<sup>5</sup> American National Standards Institute

$$P_{\text{hydraulic}} = \frac{Q \cdot h}{367} = \frac{1 \cdot 1}{367 \times 0.7} = 3.9 \quad \frac{\text{Wh}}{\text{m}^3 \cdot \text{m}} \quad Q \text{ (m}^3/\text{h)}, h \text{ (m)}$$

As reference the data evaluation sheets from the EAU from Jordan is attached in Annex 4 and from Morocco Annex 5 are attached.

### 3 Energy Audits (EAU)

According to ISO 50,000.1 an Energy Audit is a complete evaluation and monitoring system for the whole water company with established departments and reporting structures and specified PI. The ISO norm specifies the following tasks:

- 1) The purpose of this International Standard (IS) is to enable organizations to establish the systems and processes necessary to improve energy performance, including energy efficiency, use and consumption. Implementation of this IS is intended to lead to reductions in greenhouse gas emissions and other related environmental impacts and energy cost through systematic management of energy.
- 2) This IS specifies **energy management system (EnMS)** requirements, upon which an organization can develop and implement an energy policy, and establish objectives, targets, and action plans which take into account legal requirements and information related to significant energy use.
- 3) This IS is based on the Plan - Do - Check - Act (PDCA) continual improvement framework and incorporates energy management into everyday organizational practices.
- 4) **The disadvantage of this IS is:**  
This IS does not describe specific performance criteria with respect to energy.
- 5) **But it is open and gives a good indication for the general goal:**  
This IS is applicable to any organization wishing to ensure that it conforms to its stated energy policy and wishing to demonstrate this to others, such conformity being confirmed according to the following level A or B:  
A self-evaluation and self-declaration of conformity, or by  
B certification of the energy management system by an external organization.

Before a water utility will introduce an EAU according to ISO 50,000.1, the utility should undertake a self evaluation of their Pump Life Cycle Management (see Figure 1). The improvement of the different steps indicated in this cycle is the preconditions for the performance improvement of pumps:

- Operation performance improvements could be achieved with training and motivation of the staff,
- while maintenance and optimisations first of all requires the required budgets.

 The application of the ISO (internally or externally executed audited) will only improve the data base of the performance of the pumps but not change the physical conditions at the site!

## Step 5: Evaluation of the Pump Life Cycle Management

### KPI 1 Target Efficiency

The following target efficiencies (pump & motor) are recommended for horizontal pumps:

- 60-70% for smaller pumps and (motor 85-90%, pump 70-75%)
- 75-85% for larger pumps (motor 95%, pump 87-89%)

Stable operation conditions from a PS into an elevated reservoir will guarantee higher efficiency compared with pumping conditions into TS with larger variations in pressure.

Variation in Pressure or flow will affect the overall pump efficiency and also reduce the life cycle of the pump.

➔ The right specification of individual pumps or combinations is the challenge of the design engineers!

The importance of the energy cost is highlighted in the following Figure 6, normally the initial investment cost are between 5 and max 10% depending on the electricity tariff. Normally more than 90% of the life cycle costs for the pumps are spent on electricity!

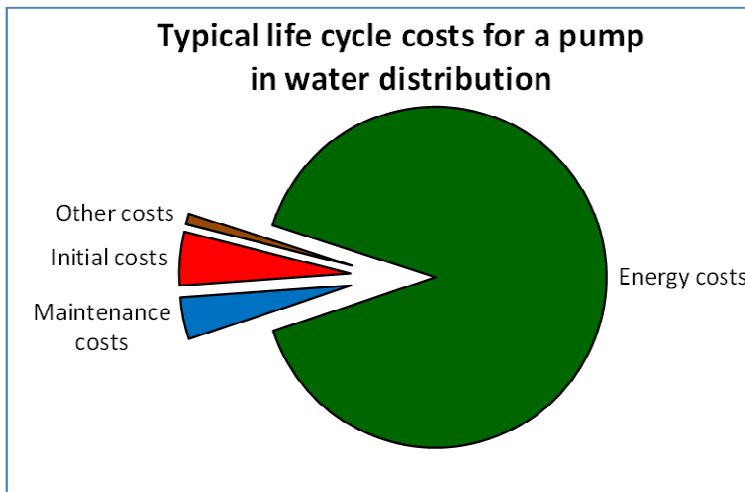

Figure 6 Life cycle cost for a pump (HW data)

Once the inspection of the PS or the individual pump has been undertaken, the analysis starts to evaluate the cause of the reduction of the efficiency (if relevant). Each pump as well as all technical equipment has its life cycle as indicated above. The technical designed period of a pump is about 15 to 20 years if all operation conditions are respected! The financial evaluation is normally undertaken for a period of 10 years.

Also the conditions are depending on the time, for which the pump was operated (full or only part time operation). Regular and complete maintenance for all mechanical and hydraulic parts using original spare parts can extend this life cycle far beyond the designed period. In Morocco and Tunisia - in the investigated areas - the pumps are working already over 30 years.

Figure 7 indicates the required steps to be undertaken in order to maintain the pumps with high performance for a long period of time after installation & commissioning:

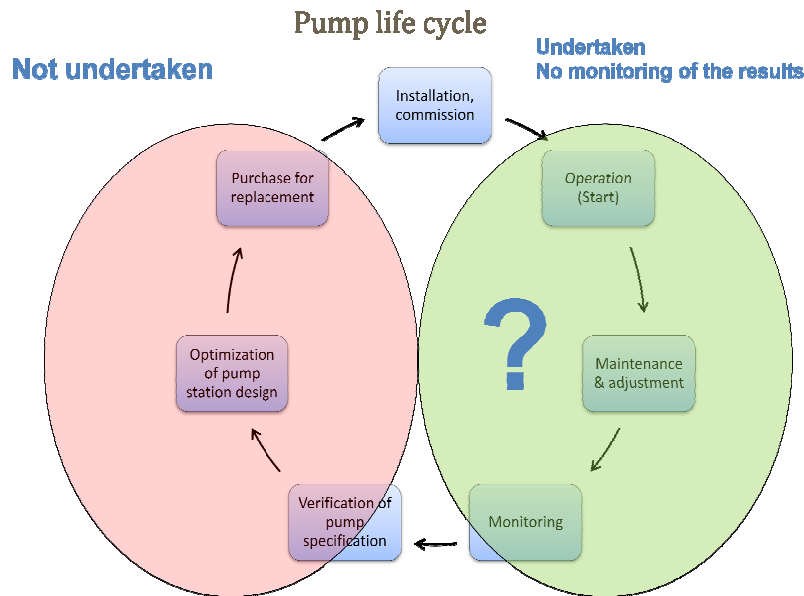

Figure 7 Pump performance evaluation (life cycle)

- 1) Following up and respecting the operation conditions regularly through **Energy Checks:**
- 2) Maintain the pumps regularly  
(greasing, changing of bearings, complete overhauling etc.)
- 3) Verification and optimisation of pump specifications through **Energy Analysis:**
- 4) modification or replacement of pumps

Step 1 and 2 of the life cycle are partially undertaken in developing countries, but the required steps 3 and 4 are often totally neglected due to staff, maintenance and financial constrains.

Following the life cycle of a pump or a PS it is proposed to do the EA according to the following five steps. The guidance is prepared to gives indications to the O&M teams but the list might not be complete. The presented comments and recommendations are based on the inspections in Tunisia (O&M Division Médenine) and Morocco (DCA).

### Inspection 1 Operation and Monitoring

The first step of the inspection is the evaluation of the operation and monitoring. All data should be analysed and the PS has to be inspected in detail to verify if all

- equipment like pumps, valves, non return valves are working,
- all valves are open or throttled during operation and
- instrumentations are working (flow meters, pressure gauges, power meter etc.).

### Inspection 2 Verification and Optimisation

During the EA it is very important to check if the hydraulic conditions have changed (reference is made to Figure 4) in order to operate the pumps at the designed duty point (reference is made to Figure 5). The following general reasons were observed during EAs:

- reduction in the yield of the wells,
- changing of the hydraulic condition in the TS
  - loss of head due to lower production and
  - increase of pressure due to deposits in the transmission line

These changes will occur over the years; they are often not noticed from the engineers and will damage the pumps completely. For the verification and optimisation it is very important, that all original data from the manufacturer as well as all O&M information are available for the analyses. Otherwise the EA can not be based on solid ground.

### Inspection 3 Maintenance and Adjustment

The inspection of the *Work Shops* (WS) can give important information concerning the maintenance undertaken. The following questions have to be evaluated:

- Are maintenance reports prepared, (work shop cards)
- Evaluation of the damages of the pumps e.g. corruptions, erosion, cavitation and mechanical damages etc.
- Are the pumps regularly maintained and overhauled :
  - from a work shop from the water utility or
  - a private work shop
- Which parts are replaced:
  - only the mechanical parts or
  - also the hydraulic components like impellers
  - what is the source of the spare parts (locally manufactured, original parts)
  - what is the quality of the spare parts
- Evaluation of the WS:
  - staff and their qualification
  - facilities e.g. tool, spares, transportation etc.
- Evaluation of the performance achieved:
  - are performance tests undertaken after maintenance
  - are records of the maintenance kept in the relevant departments

### Inspection 4 Modification and or Replacement

During the annual EA a detailed inspection has to be undertaken to verify the condition of the pumps and the PS. If required the pumps could be modified e.g. trimming of impellers or adding frequency regulations if the conditions have changed. Otherwise the pumps have to be replaced. This is already a good step forward to improve low performance of the existing pumps. Only if regular funds are available in order to undertake investments by

- replacing pumps and accessories like valves with high friction losses,
- renewing the panels, instrumentations and gauges,
- automating the operation of these pumps also with frequency regulated drives

energy efficiency of the pumps can be improved!

### Inspection 5 Evaluation of the O&M Organisation

The set up of the O&M organisation plays a major role in the pump life cycle management of the PS: The Operation Department (OD) has to

1. Step EC: follow up of the daily and monthly monitoring,
2. Step EA: carrying out annual EA, initiating maintenance if required and
3. Step: demanding replacement of damaged equipment during budget preparations.

Therefore the OP is the core unit for the energy management of a water utility counting on the required support of the maintenance WS and Planning Department.

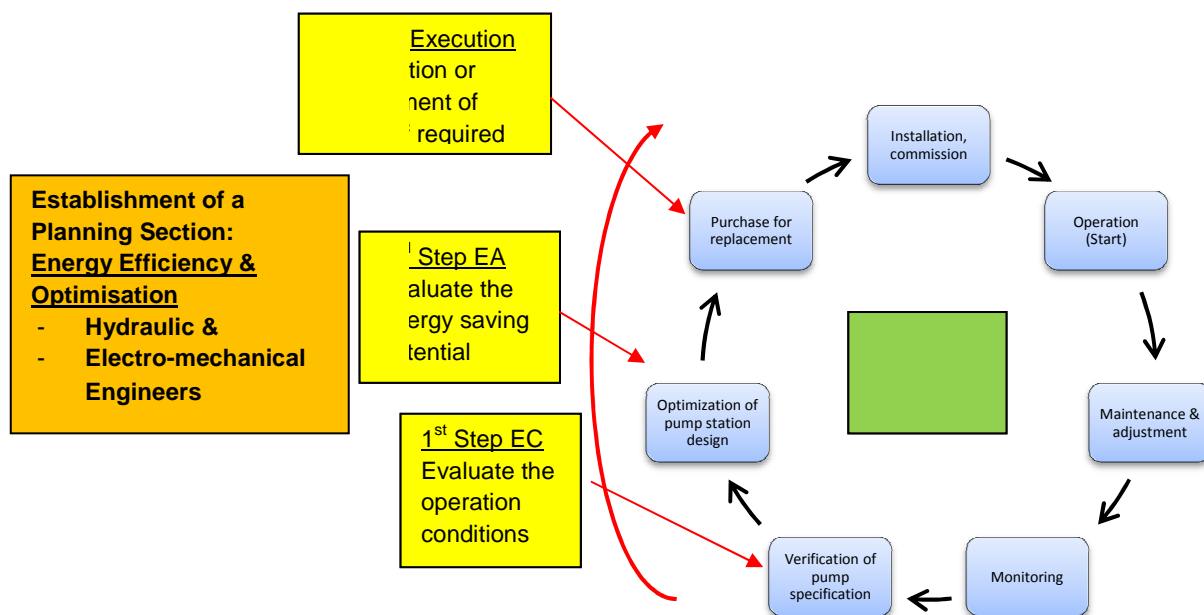

Figure 8 Institutional set up of PLCM

#### Recommendation:

For the execution of the individual EA a qualified team specially dedicated to the PS with special electromechanical knowledge is required. This team could be attached to the planning section. Normally the O&M have not enough time and dedication to this task.

These teams can be assisted by specialised consulting teams to carry out energy audits or local works shops to do maintenance.

E.g. at Hamburg Water (HW) has the following 2 sections within the planning department which are working exclusively on the optimisation of the PS & well field in order to maintain the service level and to achieve energy saving measures. These sections are working in close cooperation with the concerned O&M departments.

Section1: Surface pumping stations (about 20 PS)

Section 2: Well fields (about 400 production wells)

All overhauling of surface pumps is undertaken from the workshops of the concerned manufacturers which are available in Germany e.g. KSB, Flow Serve, Ritz & Vilo etc.



## Step 6: Financial Evaluation & Ranking

According to the above mentioned technical evaluation for the different groups of energy consumers, the required investments have to be calculated for the pre-selected facilities as follows:

### 6.1 Target efficiency for the Optimised Operation Conditions

Only PSs & WF with positive saving potentials should further be taken into consideration:

- less than 80% efficiency in special cases like very large stations
- less than 70% efficiency for all other stations and wells.

### 6.2 Calculation of the Required Investment Costs

#### 6.2.1 Rated Power (RP)

The future demand ( $Q \text{ m}^3/\text{h}$ ) for the PS should be specified:

- From the management of the utility according to their strategic planning
- This annual demand can be divided by 365 day and 24 hours to get the discharge of the PS (calculated  $Q_{2014}/365*24$ )

in order to calculate the **Rated Power (RP) in P (kW)**

For the investments of the new pumps a peak factor for seasonal and spare capacities of 50% should be added if required:

$$[P_{\text{rating}}=Q*h/(367*\eta)*1,5].$$

#### 6.2.2 Calculation of the Rated Costs:

Specific Investment Costs (SIC) should be derived from executed projects; as reference the calculation from the Jordan projects is indicated in Figure 9:

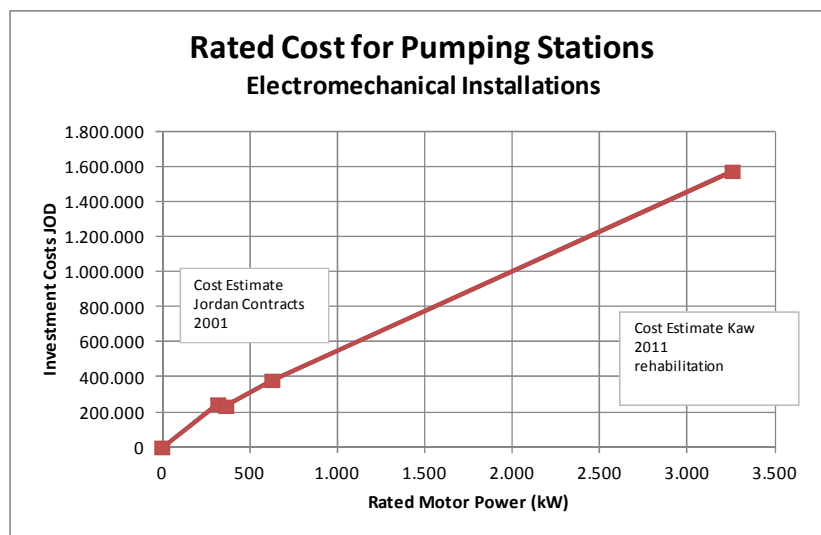

Figure 9 Investment Costs of the Rated Power <sup>6</sup>

<sup>6</sup> 1 Jordan Dinar = 1,14238 €

In order to evaluate the cost saving potential against the required investment costs, the Net Present Value Method<sup>7</sup> (NPVM) is used at HW. An excel table was developed where the user fills in the required input data.

In order to practice the proposed cost evaluation strategy, the following 2 study case are explained in more detail:

Study case 1 Morocco Daourate treated water PS

- 1 Target Efficiency  $\eta = 82\%$  (confirmed from the catalogue from manufacturers)
- 2 Flow Rate  $Q = 2,800$  l/s (specified from the Management of ONEE)
- 3 Investment costs 6 Mill MAD for 3 pumps (derived from executed Projects)
- 4 The saving potential was calculated as follow:
  - With the actual operation condition 2,440 kWh are consumed from 3 pumps
  - With 3 new pumps operated with higher efficiency ( $\eta_{\text{pump \& motor}} = 82\%$ ) only 2,244 kW is required (saving potential 196kW)
  - An annual saving potential of
    - 1,7 Mill kWh/a and
    - 1,54 Mill MAD/a is calculated

The following Table 1 was develop to fill in the input data and to calculate the energy & cost saving potential.

Energy and Cost Saving Potential Daourate: Treated Water Station											
	Flow		Flow	HMT	Hydraulic Energy (Output)	Electric Energy (INPUT)		Energy Saving		Cost Savings	
	3 pumps	1 pump				Required (82%)	Actually				
	(l/s)		(m3/h)	(m)	(kW)	(kW)	(kW)	(kW)	(kWh/a)	(MAD/a)	(EURO/a)
<b>3 New Pumps Standard Flow (90%)</b>	2,800	933	10,080	67	1,840	2,244	2,440	196	1,715,486	1,543,937	140,358

**Table 1 Input table for the calculation of the cost saving potential**

The following 2 options for the financial evaluation for the Daourate treated water PS are compared, in order to calculate the cost benefit of the proposed investment:

- Option 1 without investments
- Option 2 with investments of 3 new pumps, estimated investment costs 6 Mill MAD

<sup>7</sup> Definition from Wikipedia: NPV can be described as the “difference amount” between the sums of discounted: cash inflows and cash outflows. It compares the present value of money today to the present value of money in the future, taking inflation and returns into account.

The following parameters for the evaluations were used:

- Estimated investment costs for 3 pumps: 3 x 2 Mill MAD = 6 Mill MAD.
- Actual average energy costs 0,9 MAD/kWh, 4% increasing annually
- Annual Maintenance cost 3 x 8.000 MAD, 3% increasing annually, after 10 years 3 x 70.000 MAD costs for overhauling, total 210,000 MAD.
- 0,2 reduction in efficiency annually

Project Option 1 without investment			Project Option 2 with investment		
	Costs	Rising factor	Energy		
	MAD	% p.a.	kWh	MAD	% p.a.
Investment	0			6,000,000	
annual Maintenance p.a.	24000			8000	
Rising costs for Maintenance		3.0			3.0
initial Energy Costs	0.9			0.9	
Rising costs for Energy		4.0			4.0
initial Energy Consumption p.a.			21,374,400		
Wearing in Pump		0.2			0.2
after 10 years extra maintenance	210,000			210,000	

Table 2 Input data file for the Net Present Value comparison

The complete table is attached in Annex 6. The following Figure 10 shows the cost benefit analyses for the investment of 3 pumps:

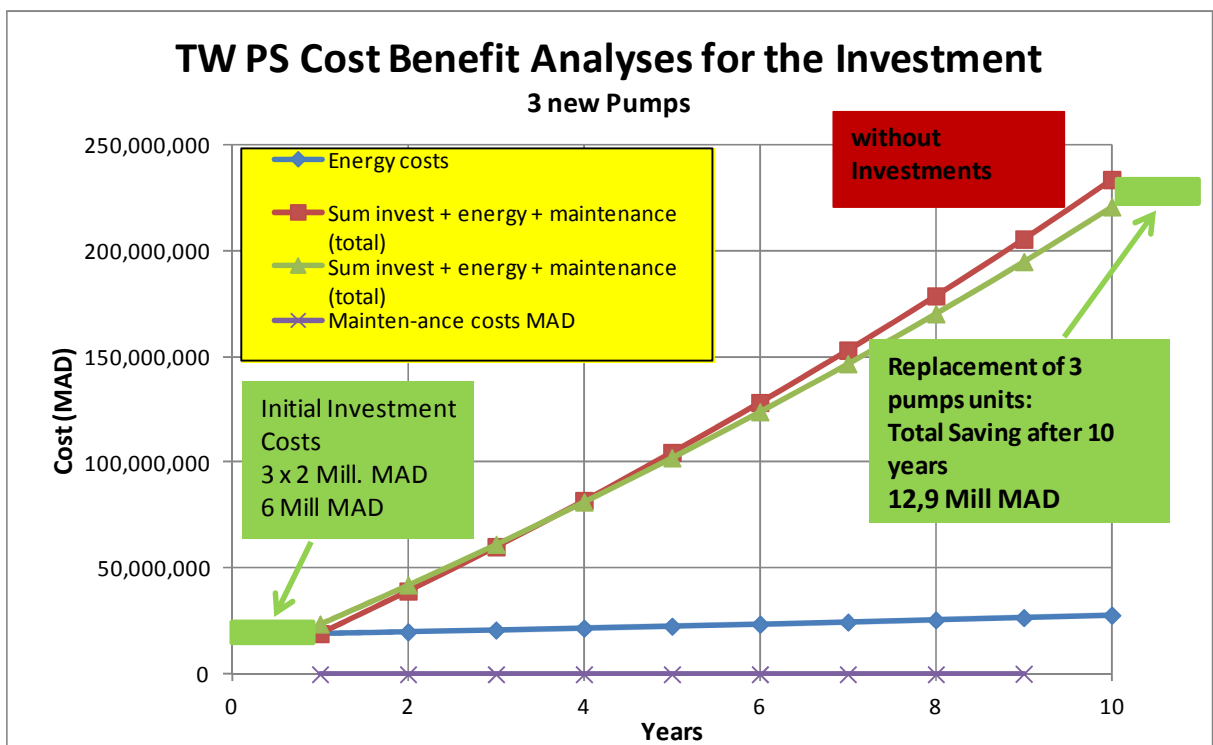

Figure 10 Cost benefit analyses Daourate TW PS

With the investment of 3 Mill MAD for 3 new pumps, about 12.9 Mill MAD could be saved. But due to the good water quality and the stable conditions, technically these pumps might work over 30 years. This experience is gained from the existing pumps; unfortunately they are not well specified for the actual operation conditions (required 67hm available 80mh).

After 4 years the investment costs of 3 Mill MAD are already recovered through the energy saved due to the higher efficiency of the new pumps (actually 75%, new pumps 82%) as shown in the following Figure 11.

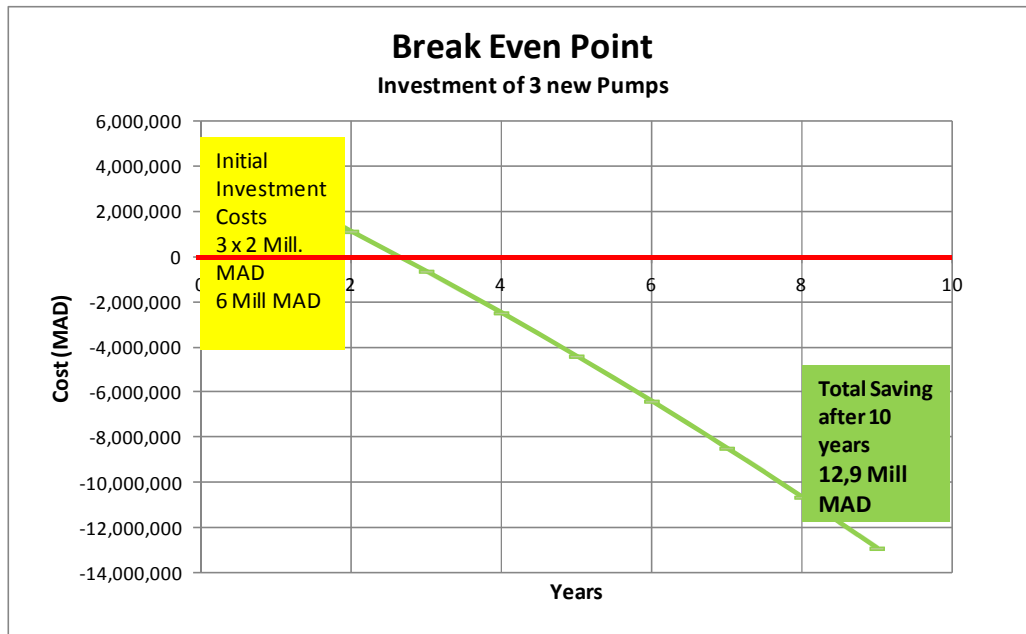

Figure 11 Financial evaluation Break Even Point

Study Case 2 Tunisia SE Division Médenine

For this division the billed amount from the energy company STEG and the cost saving potential for the major PS are displayed in Figure 12.

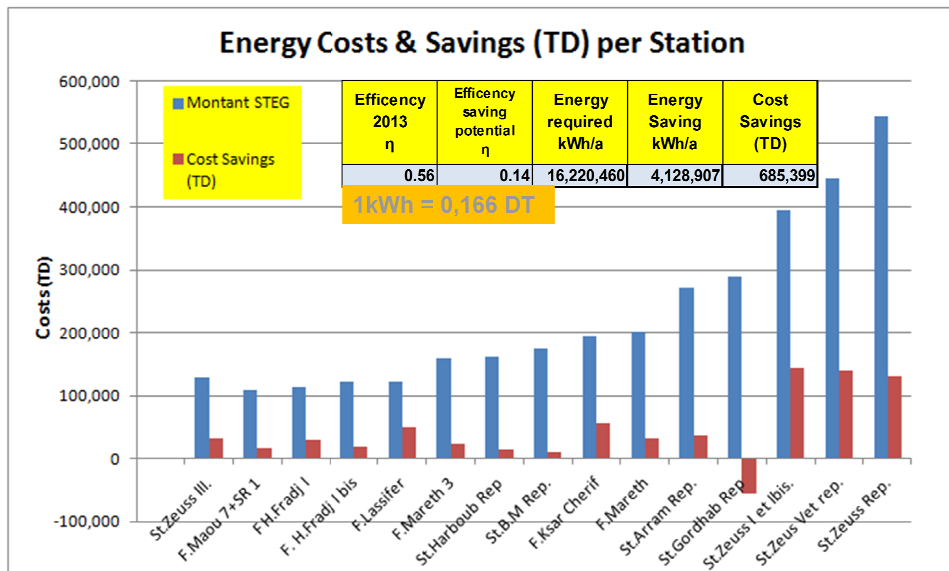

Figure 12 Billed amount (STEG) and the cost saving potential SE Tunisia

The energy saving potential was calculated if the actual efficiency will improved up to 70%:

- 4.12 Mill kWh and
- 685,000 DT<sup>8</sup> annually could be saved.

This financial evaluation is a simple procedure which can be easily applied for Energy Audits.

---

<sup>8</sup> 1 Euro = 2,1 DT

Annex 1 Location Map of Water Direction Cote Atlantique (ONNE)

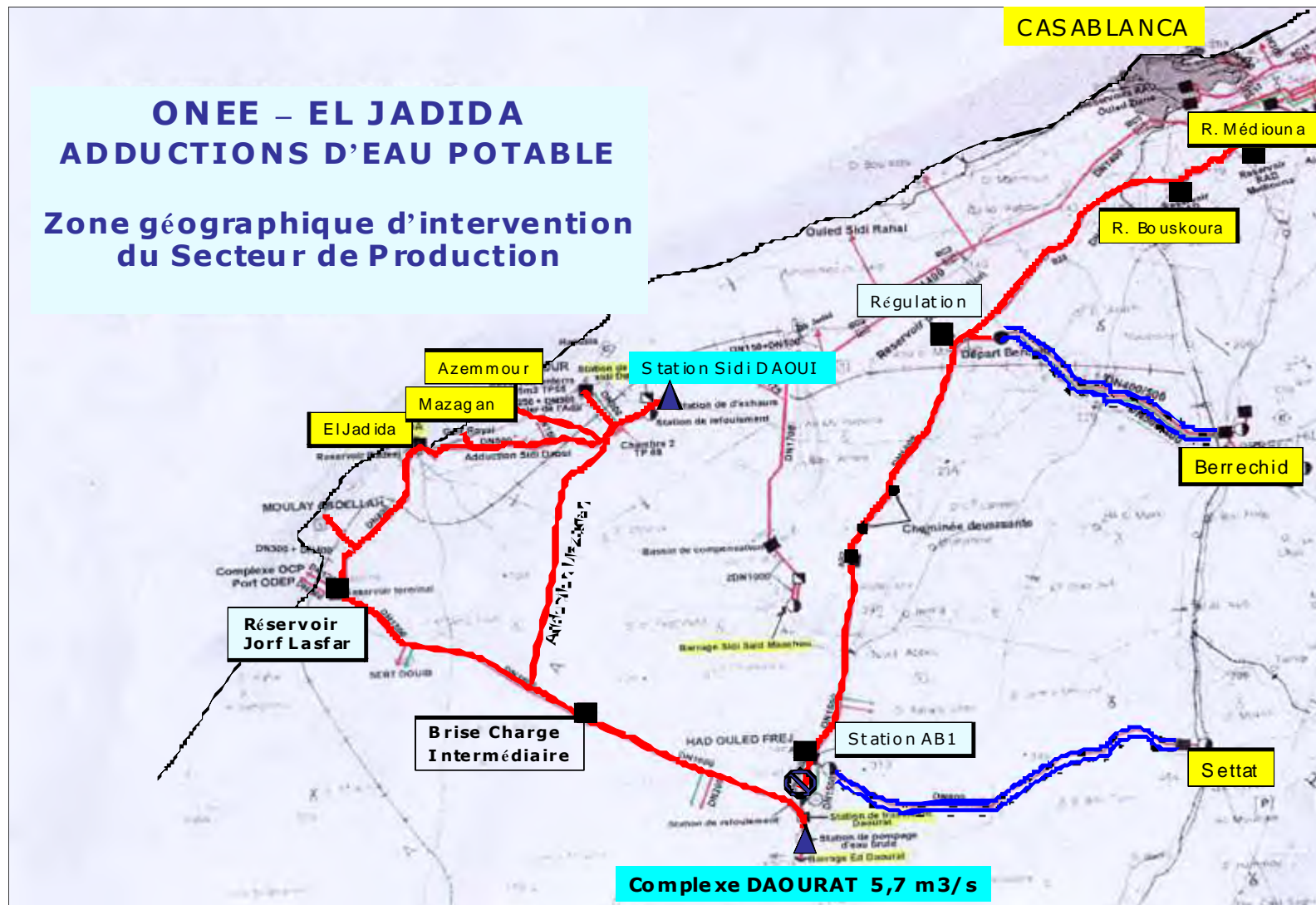

Annex 2 Evaluation of the Operation and Maintenance Budget of a water utility

(JWU Palestine, Aleppo Syria)

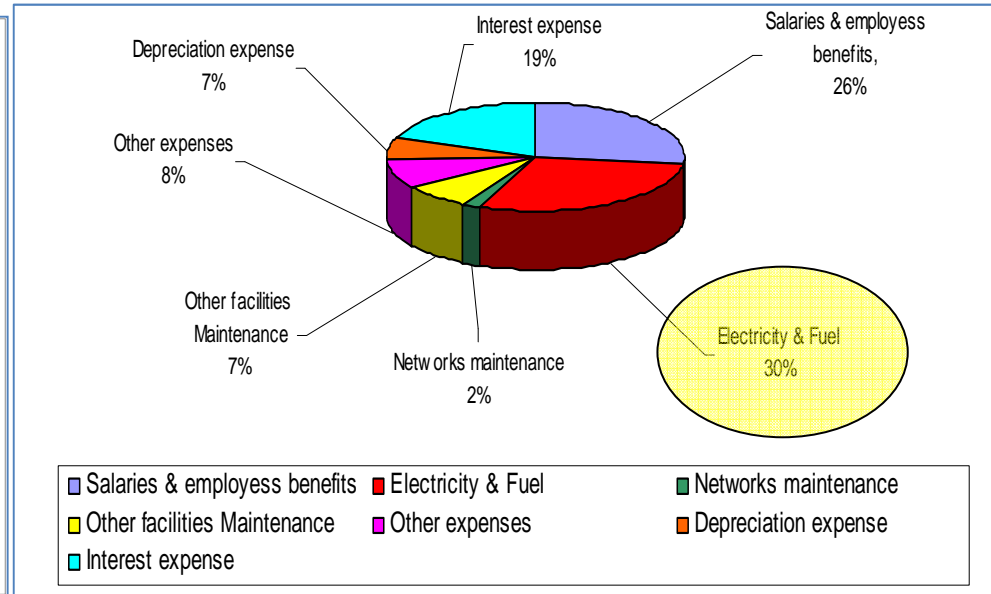
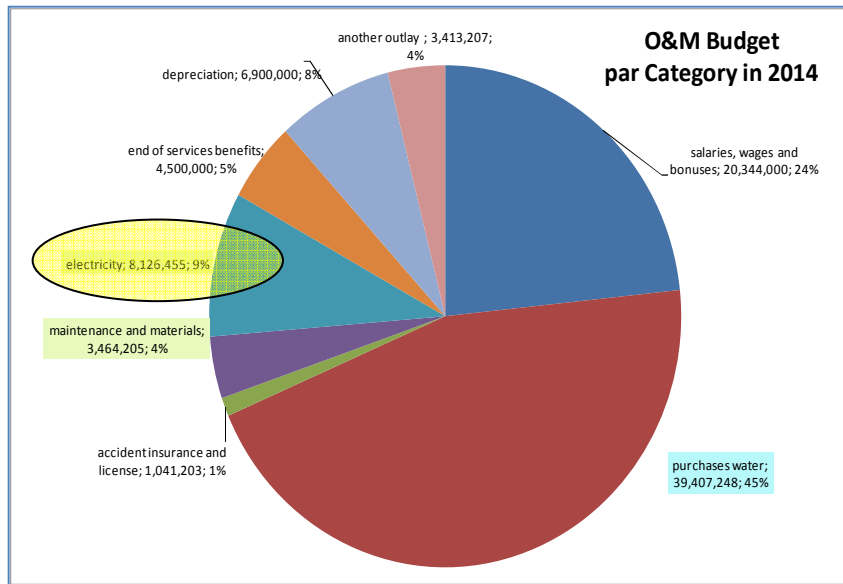

Annex 3 Ranking of PS Operation Department Medinine

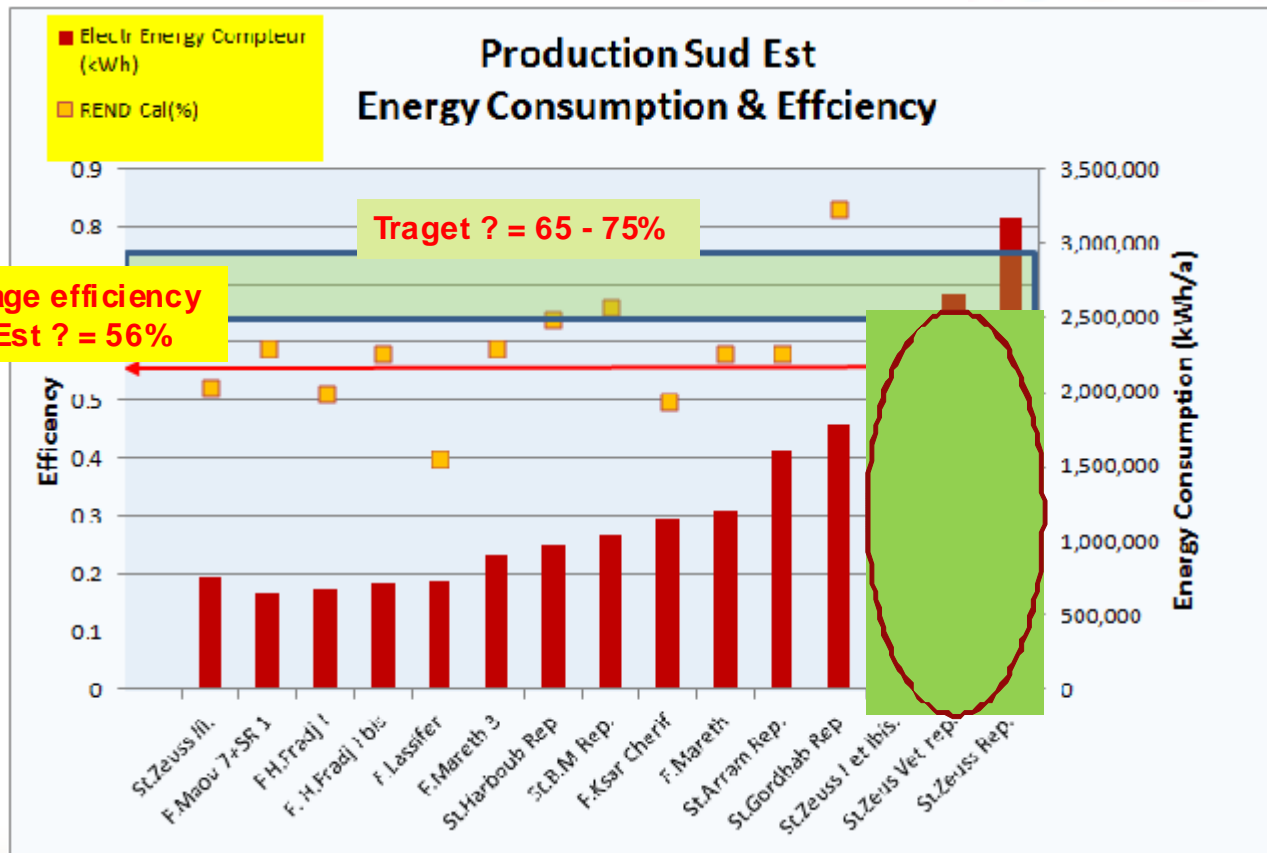



Module 1: Evaluation of Raw and Drinking Water Pump Stations

Annex 4 Evaluation Table for Pump Test (Model Morocco ONEE)

Groupe N°	1	2	3	4	5	7	8	9
Date	12.03.2015	Groupe en arrêt - Moteur en révision	12.03.2015	12.03.2015	12.03.2015	11.03.2015	11.03.2015	11.03.2015
heure	12H05		16h45	10h15	14h20	16h10		17h
N°Serie pompe	M-117 133		M- 117 135	M-117 136	M-117 137	HW-80259160-2	M-117 138	HW-80259160-3
N°Serie Moteur	LCL2031141		LCL2031136	12E6Q008B-1	12E6Q007B-1	MW 051MB/1	LCL2031140	12E5Q012A-1
DMES de la pompe	1983		1983	1983	1983	1998	1983	1998
Date de dernière révision de pompe	17.10.2012		29.09.2010	13.10.2011	13.07.2013	02.01.2012	17.09.2013	30.05.2013
Nb d'heure de fonctionnement depuis dernière révision	6638		17593	10667	7731	17100	5964	10419
DMES du moteur	1983		1983	2012	2012	1998	1983	2012
Debit relevé m3/s	0.872		0.923	0.965	0.927	1.000	0.980	0.827
Pression Aspiration(bar)	0.400		0.420	0.440	0.350	0.250	0.400	0.440
Pression Refoulement(bar)	10.200		10.150	10.400	10.200	10.400	10.400	11.200
Diametre aspiration (m)	0.600		0.600	0.600	0.600	0.500	0.600	0.500
Vitesse asp	3.086		3.266	3.415	3.280	5.096	3.468	4.214
Diametre refoulem (m)	0.400		0.400	0.400	0.400	0.400	0.400	0.400
Vitesse Refoul	6.943		7.349	7.683	7.381	7.962	7.803	6.584
(Vr2 -Va2)/2g	1.971		2.209	2.414	2.228	1.908	2.490	1.305
HMT (m)	101.931		101.455	104.006	102.698	105.438	104.490	111.057
Tension (Kv)	10.300		10.300	10.400	10.300	10.300	10.300	10.300
courant (A)	76.000		80.500	80.800	80.400	83.300	83.800	77.850
Puissance_abs (kw)	1136.000		1190.000	1192.000	1193.000	1233.000	1240.000	1110.000
cos@	0.830	0.830	0.820	0.830	0.830	0.830	0.800	
<b>Renderm,Groupe</b>	<b>0.768</b>		<b>0.772</b>	<b>0.826</b>	<b>0.783</b>	<b>0.839</b>	<b>0.810</b>	<b>0.812</b>

NB : Les mesures électriques ont été relevées à partir des relais de protection de type SEPAM M40.

\* Les mesures des débits ont été relevées à partir des deux débitmètres électromagnétiques DN 1400 installés sur chacun des collecteurs de refoulement des deux filières.

\* les mesures de pressions ont été relevées à partir des manomètres installés aux entrées des aspirations et aux sorties des refoulements de chaque pompe.

Module 1: Evaluation of Raw and Drinking Water Pump Stations

Annex 5 Data Evaluation Sheet from the EA Jordan

Priority List for the Pumping Stations														
Responsible Body	Pumping Station	Q 2011	Height + friction	El. Cons. 2011	η <sub>2011</sub>	Saving	Saving	Power Rating	Investment Costs	Pay-Back	Spec Investment	Ranking		
		(m <sup>3</sup> /yr)	[m]	(kWh/yr)		[kWh/yr]	[JOD/yr]	(kW)	(JOD)	(years)	(JOD/kWh)			
Mihayuna WC	Amman	1 Zay	61,203,273	1,394	303,741,000	76.5%	13,213,065	885,275	49,748	4,974,793	5.6	0.377	1	
		2 Al Muntaza 2	43,800,000	73	24,528,000	44.4%	13,637,673	913,724	2,486	1,243,188	1.4	0.091	2	
		3 Ras El Ain Turbine	4,380,000	230	3,921,370		3,921,370	333,316	448	559,556	1.7	0.143	3	
		4 Wadi Eseer	2,911,390	103	2,461,528	33.1%	1,298,944	87,029	174	52,257	0.6	0.040	4	
		5 Shafa	3,581,416	88	2,232,296	38.5%	1,003,197	67,214	184	55,246	0.8	0.055	5	
Middle Governorates Water	Balqa Zar	12 At Tamween	1,752,000	125	2,129,649	28.0%	1,277,177	85,571	286	143,164	1.7	0.112		
		15 Shraya PS	3,003,907	299	5,536,221	44%	2,268,223	151,971		780,000	5.1			
		16 Yazidieh	2,692,212	277	4,598,055	44%	1,695,203	113,579		500,000	4.4			
Yamouk WC	Yamouk	18 Wadi Arab PS PS3	21,374,791	214	19,211,160	65%	2,592,794	173,717	3,049	1,524,434	8.8			
		19 PS 2	20,498,791	210	17,788,111	66%	2,148,707	143,963	2,869	1,434,632	10.0			
		20 PS 1	20,498,791	231	22,085,719	58%	4,882,374	327,119	3,156	1,578,095	4.8			
		21 PS 0	4,169,231	230	5,454,091	48%	1,970,265	132,008	639	319,578	2.4			
		23 Hofa PS	3,171,173	185	3,149,252	51%	1,017,855	68,196	391	195,517	2.9			
		24 Jafhiya PS	1,688,302	333	3,155,521	49%	967,103	64,796	375	187,365	2.9			
		25 Sumaya PS	2,045,751	128	3,592,882	20%	2,573,590	172,431	175	87,268	0.5			
Southern Governorates Water Facilities	Karak	26 Al Ghwair	-	-	3,047,602				521	260,394				
		27 As Safi	-	-	1,062,312				182	90,951				
		28 Ein Sara	800	-	843,788	50%	1,855,323	124,307		144	72,242	4.3	4	1-5
		29 Al Qasr	-	-	787,939					135	67,461			
		30 Karak	-	-	442,771					76	37,909			
	Tafilah PS	31 Hasa PS No. 1	2,244,516	162	2,802,852	35%	1,484,275	99,446	242	120,956	1.2	0.081491314		
		32 Hasa PS No. 2	2,244,516	204	2,663,825	47%	1,004,392	67,294	304	152,223	2.3	0.151557363		
		33 Hasa PS No. 3	2,244,516	125	3,371,229	23%	2,348,659	157,360	188	93,802	0.6	0.03993864		
		34 Zibdah PS	900,786	153	1,207,180	31%	706,798	47,355	92	45,901	1.0	0.06494219		
Aqaba WC		35 Ad Disi	20,829,884	330	37,459,737	50.0%	10,702,782	717,086	4,582	2,290,835	3.2	0.214	1	
		36 Disi Aqaba Turbines	20,829,884	-	68,919,429		68,919,429	5,858,151	7,868	3,933,757	0.7	0.057	2	
		<b>Total</b>	<b>304,182,394</b>		<b>581,254,765</b>	<b>48%</b>	<b>145,026,589</b>	<b>11,027,914</b>	<b>82,413</b>	<b>22,094,327</b>	<b>2.00</b>	<b>0.152</b>		
						<b>Power Saving</b>	<b>25%</b>							

Module 1: Evaluation of Raw and Drinking Water Pump Stations

Annex 6 Life cycle costs of a pump

<b>Project Option 1 without investment</b>		Costs	Rising factor	Energy	Year	Invest	Power demand (with wearing)	Power Saving	Energy charge rate	Energy costs	Maintenance costs	Sum invest + energy + maintenance (per year)	Sum invest + energy + maintenance (total)	Sum invest + energy + maintenance (total)
		MAD	% p.a.	kWh		MAD	kWh	kWh	ct/kWh	MAD	MAD	MAD		
					1	0	21,374,400		90.0	19,236,960	24,000	19,260,960	19,260,960	23,701,023
<b>Investment</b>		<b>0</b>			2		21,417,149		93.6	20,046,451	24,720	20,071,171	39,332,131	42,146,808
annual Maintenance p.a.		24000			3		21,459,983		97.3	20,890,006	25,462	20,915,468	60,247,599	61,368,692
Rising costs for Maintenance			3.0		4		21,502,903		101.2	21,769,057	26,225	21,795,283	82,042,882	81,399,330
initial Energy Costs		0.9			5		21,545,909		105.3	22,685,099	27,012	22,712,112	104,754,993	102,272,753
Rising costs for Energy			4.0		6		21,589,001		109.5	23,639,688	27,823	23,667,511	128,422,504	124,024,420
initial Energy Consumption p.a.				21,374,400	7		21,632,179		113.9	24,634,446	28,657	24,663,104	153,085,608	146,691,285
Wearing in Pump			0.2		8		21,675,443		118.4	25,671,064	29,517	25,700,581	178,786,189	170,311,856
after 10 years extra maintenance		210,000			9		21,718,794		123.2	26,751,302	30,402	26,781,705	205,567,893	194,926,262
					10		21,762,232		128.1	27,876,997	31,315	28,118,312	233,686,205	220,786,320
					Σ					233,201,072	485,133	233,686,205		

<b>Project Option 2 with investment</b>		Costs	Rising factor	Energy	Year	Invest	Power demand (with wearing)	Power Saving	Energy charge rate	Energy costs	Maintenance costs	Sum invest + energy + maintenance (per year)	Sum invest + energy + maintenance (total)	Sum invest + energy + maintenance (total)
		MAD	% p.a.	kWh		MAD	kWh	kWh	ct/kWh	MAD	MAD	MAD		
					1	6,000,000	19,658,914		90.0	17,693,023	8,000	23,701,023	23,701,023	23,701,023
<b>Investment</b>		<b>6,000,000</b>			2		19,698,232		93.6	18,437,545	8,240	18,445,785	42,146,808	42,146,808
annual Maintenance p.a.		8000			3		19,737,628		97.3	19,213,397	8,487	19,221,884	61,368,692	61,368,692
Rising costs for Maintenance			3.0		4		19,777,104		101.2	20,021,897	8,742	20,030,639	81,399,330	81,399,330
initial Energy Costs		0.9			5		19,816,658		105.3	20,864,418	9,004	20,873,422	102,272,753	102,272,753
Rising costs for Energy			4.0		6		19,856,291		109.5	21,742,393	9,274	21,751,667	124,024,420	124,024,420
initial Energy Consumption p.a.				19,658,914	7		19,896,004		113.9	22,657,313	9,552	22,666,865	146,691,285	146,691,285
Wearing in Pump			0.2		8		19,935,796		118.4	23,610,732	9,839	23,620,571	170,311,856	170,311,856
after 10 years extra maintenance		210,000			9		19,975,667		123.2	24,604,272	10,134	24,614,406	194,926,262	194,926,262
					10		20,015,619		128.1	25,639,620	220,438	25,860,058	220,786,320	220,786,320
					Σ					214,484,609	301,711	220,786,320		
<b>Saving after 10 Years</b>												<b>12,899,885 MAD</b>		

Guidelines for Energy Checks and Energy Analysis in Water and Wastewater Utilities

## Module 2: Energy Recovery in „Hydroelectric Power Installations“ in the Drinking Water Supply

(Prepared and tested with the assistance of Aquaba Water)



(Participants of the Aquaba Water team)

**September 2015**

(Presented and approved from the EE Task Force at the Conference in Alexandria)

Prepared by Holger Laenge

**Prepared for the ACWUA TASK Force:** Energy Efficiency for application by members of the Arab Countries Water Utilities Association

**GIZ Program:** Strengthening the MENA Water Sector through Regional Networking and Training (ACWUA WANT)

**Task force name (TF EE):** Energy Efficiency in Water and Waste Water Utilities  
**Target of the TF EE:** Instruments to enhance energy performance (efficiency, use, consumptions) are promoted amongst ACWUA members

Project manager of the GIZ:

Dr. Thomas Petermann, ACWUA WANT, GIZ Eschborn, Regional Department 3300

## Table of content

<b>Preface</b> .....	<b>4</b>
<b>Introduction</b> .....	<b>4</b>
<b>Step 1: Identification of the Excessive Energy Potential</b> .....	<b>5</b>
<b>Step 2: Evaluation of the General Hydraulic Conditions</b> .....	<b>5</b>
<b>Step 3: Evaluation of the Operation Conditions of the System</b> .....	<b>6</b>
<b>Step 4 Evaluation of the Energy Generation Potential</b> .....	<b>9</b>
<b>Step 5: General Technical Application</b> .....	<b>10</b>
<b>Step 6: Life Cycle Cost Calculation</b> .....	<b>13</b>
<b>Study Case Aquaba</b> .....	<b>15</b>
Brief system description.....	16
Required Measurement .....	16
Measurements Undertaken.....	17
<b>Applications at Hamburg Water</b> .....	<b>21</b>
Case 1 Water Work Stellingen .....	21
Case 2 Lübeck .....	23

## List of Tables

Table 1 Evaluation of the system conditions .....	7
Table 2 Calculation of the cost saving potential .....	13
Table 3 Input table for the net present value method .....	14
Table 4 Output table of the net present value method.....	14
Table 5 Flow – Pressure measurements at the entrance of the HTR .....	17

## List of Figures

Figure 1 Evaluation of the general hydraulic conditions.....	6
Figure 2 Operation condition of the gravity system.....	7
Figure 3 Relation between the system curve and the performance curve .....	7
Figure 4 Specification of the operation point.....	8
Figure 5 Frequency regulated turbine (80 to 120%) .....	9
Figure 6 Calculation of the energy generation and cost recovery potential .....	10
Figure 7 Basic concept of using pumps as turbines.....	10
Figure 8 Selection of Pumps used as Turbines (examples from KSB catalogue).....	11
Figure 9 Regulations and precautions for the save operation .....	12
Figure 10 Regulation of the system with large variation in flow .....	13
Figure 11 Output of the net present value method (graphic).....	15
Figure 12 System Graphic of the DISI line .....	15
Figure 13 HTR: Evaluation of the <i>Flow – Pressure</i> measurements .....	18
Figure 14 HTR with the proposed installation of the turbine.....	20
Figure 15 Task: Refilling of the reservoirs during the night from the network.....	21
Figure 16 WW Stellingen: Pump as Turbine .....	22
Figure 17 WW Stellingen: Pump as Turbine .....	22
Figure 18 Process Schema of the Turbine Lübeck .....	23
Figure 19 Hydraulic calculation in case of power cuts.....	23

## Abbreviations

ACWUA	Arab Countries Water Utilities Association
AWC	Aquaba Water Company
CAH	Consulaqua Hamburg
DS	Distributions systems
EA	Energy Analyses
EAU	Energy Audits
EC	Energy Checks
EED	Energy Efficiency Department
GIS	Geographic Information System
GIZ	Gesellschaft für Internationale Zusammenarbeit Agency for International Cooperation and Development
GL	Guidelines
HW	Hamburg Wasser (Water)
KFW	Kreditanstalt für Wiederaufbau, German Bank for International Cooperation and Development
KPI	Key Performance Indicators
NRW	Non Revenue Water
ONEE	Office National de L'Eau et l'Electricité (ONEE, Marco)
OD	Operation Department
PI	Performance Indicator
PLCM	Pump Life Cycle Management
PMU	Project Management Unit
PS	Pumping Stations
SIC	Specific Investment Costs
SONEDE	Société Nationale d'Exploitation et de Distribution des Eaux (SONEDE, Tunisia)
TF EE	Task Force Energy Efficiency
RW	Raw Water
SCADA	Supervisory Control and Data Acquisition
TS	Transmission System
TW	Treated Water
WF	Well Fields
WS	Work Shops (maintenance)
WU	Wastewater Utilities

## Preface

This module was developed in cooperation with the Aquaba Water Company in order to test the Guidelines<sup>1</sup> prepared during the project implementation. The main objective of the giz project is:

- to develop instruments to enhance energy performance efficiency (efficiency, use, consumption, generation) and
- promote them amongst ACWUA members.

This Module 2: *Energy Recovery in „Hydroelectric Power Installations“ in the Drinking Water Supply* was developed to provide applications and recommendations for Energy recover options. It is based on the experience of the consultant gained at Hamburg Water.

### Activities undertaken

Aquaba Water Company (AWC) was selected from giz as case study for the evaluation of the energy recovery potential which was identified at the main transmission line from the DISI well field to the terminal reservoir located above Aquaba City. AWC is interested to get further technical and financial support for the implementation of this project.

AWC was visited from the 1<sup>th</sup> to the 3<sup>rd</sup> of June in order to collect all relevant information and to inspect the transmission line with their attached pressure break tanks (PBT) and the high terminal reservoir (HTR). At the 4<sup>th</sup> of June a presentation about energy generation were held at Amman, Central Work shop training room; the precondition for the installation of a pump as turbine was discussed in detail and the study case Aquaba Water Company was presented.

This 2<sup>nd</sup> Module will outline the important steps to be undertaken in order to evaluate the preconditions for the installation of a “pump as turbine”.

## Introduction

In drinking water utilities at selected places also energy could be generated if excess pressure is available. The following locations could be further evaluated for energy generation e.g.:

- gravity lines with excess pressure; turbines could replace existing pressure break tanks and
- excess pressure before reservoirs which will be filled from the network.

The assessment should be undertaken normally from (electro-) mechanical engineers with good qualifications in hydraulics.

This module was developed in order to assist the user to undertake preliminary steps to evaluate their energy generation potential within their systems, this energy generation could also contribute to major energy reduction:

- used for their own production or
- injected into the national electrical power lines.

---

<sup>1</sup> Guidelines for Energy Checks and Energy Analysis in Water and Wastewater Utilities, Main authors: Eric Gramlich, M.Sc., Prof. Dr.-Ing. Markus Schröder Tuttahs & Meyer Ingenieurgesellschaft, Germany Members of DWA and German Water Partnership GWP, November 2014, Draft 2 English version

The aim of this module is to guide the user passing through the indicated individual steps. All required procedures as well as calculation methods including the relevant input tables are presented in the module. All users are invited to update the draft module in order to improve and share the experience in the operation of energy efficient water supply facilities.

According to the experience of the consultant, energy saving measure in the drinking water sector can not be generalised. The following **aspects** have to be taken into consideration:

- 1) Special *national legal procedures* for the utilities are playing an important role
- 2) The electricity tariff is an important factor, if investment measures might be cost effective
- 3) The Pump Life Cycle Management (PLCM) (procurement, O&M and optimisation) is an important tool to keep the equipment in good operation condition with high performance efficiency
- 4) Last but not least staff availability and qualifications to follow and execute the PLCM
- 5) Availability of the private sector for supply, operation and maintenance assistance should be taken into consideration.

The important condition for the save operation of a “pump as turbine” is that there is no risk for the service level to the customer:

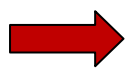
- 
- The 1<sup>th</sup> priority for a water utility is the supply service.
  - The optimisation of the system e.g. energy recovery is of secondary nature.

### Step 1: Identification of the Excessive Energy Potential

The following expertise is based on the DVGW<sup>2</sup> 613 Working Paper: Energy Recovery in „Hydroelectric Power Installations“ in the Drinking Water Supply (1994) and the experience of Hamburg Water (HW) for the installation of two turbines for energy generation.

Excessive energy is either reduced by:

**Valves** or pressure break tanks, this energy potential can be recovered by **turbines**.

The following criteria have to be taken into consideration:

- Guarantee of the service level to the customer,
- influence of other system components and
- water quality effects

The boundaries and the system facilities should be displayed in a Geographic Information System (GIS) base map attached with the relevant system data for all relevant components (e.g. information concerning: PS & TS, material, elevations, operation & maintenance data etc. See **Fehler! Verweisquelle konnte nicht gefunden werden.**).

### Step 2: Evaluation of the General Hydraulic Conditions

The following Figure 1 shows the hydraulic conditions of a gravity system, which was design for  $Q_{max}$ . If the system is not operated with the full flow capacity, remaining pressure can be

---

<sup>2</sup> German Water and Gas User Association



used for energy generation ( $\Delta h_{\text{useable}}$ ). The system can be operated with the following two options:

- Option 1:  $Q_{1 \text{ to } 3}$  remaining energy can be used for energy generation
- Option 2  $Q_{\text{max}}$  operation without a turbine

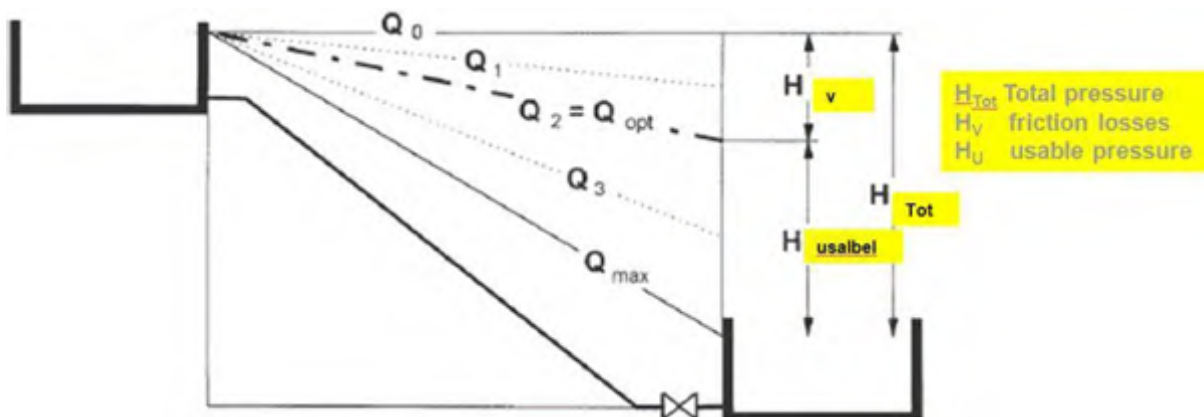

Figure 1 Evaluation of the general hydraulic conditions

### Step 3: Evaluation of the Operation Conditions of the System

The operation conditions of the system have to be analysed in order to:

- Maintain always positive pressure in the transmission line (min 4m)
- Specify the flow and pressure for a turbine based on the Flow variations during the year ( $Q_1$ ,  $Q_2$ ,  $Q_3$  and  $Q_{\text{max}}$ )
- Calculate energy generation with 70% overall efficiency for the turbine & generator and
- Evaluate the cost saving potential to calculate the cost recovery period with the estimated investments costs.

The following Figure 2 shows the operation conditions indicating the hydraulic grade line which is dependent on the flow conditions. The remaining system pressure can be used for energy generation if this pressure is not required to pressurise a transmission or distribution system.

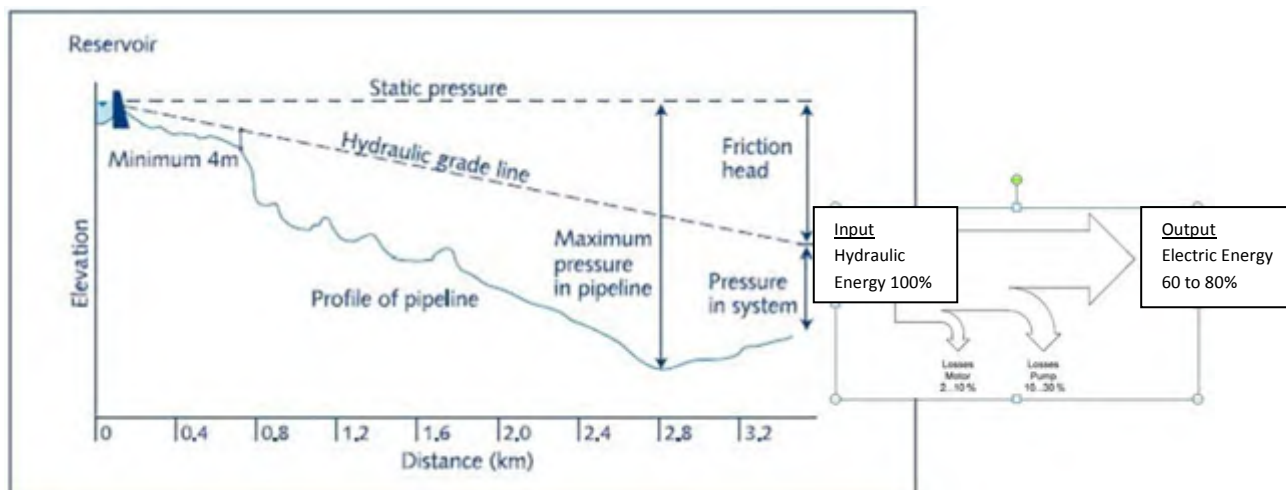
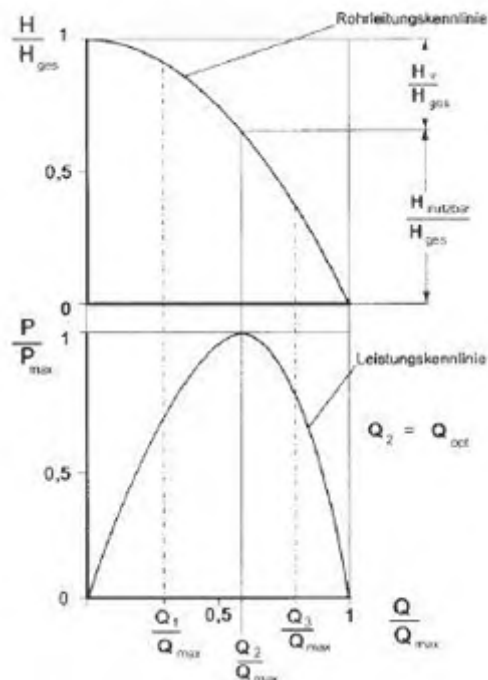

Figure 2 Operation condition of the gravity system

The following Figure 3 shows the relation between the system curve and the performance curve in order to determinate the energy generation potential:

- Low flow conditions means low energy generation potential
- **The maximum of energy generation can be achieved with 58% flow max**
- High flow conditions means also low energy generation potential, due to the increasing friction losses



$$Q_{opt} = \frac{Q_{max}}{\sqrt{3}} = 0,58 \cdot Q_{max}$$

Figure 3 Relation between the system curve and the performance curve

The following Table 1 summarises the different operation conditions:

Evaluation of the system conditions				
Water Demand	Valve position	Flow (m <sup>3</sup> /H)	Useable pressure (m)	Power generation potential (kW)
Q <sub>1</sub>	closed	zero flow	max	zero
Q <sub>2</sub>	<i>throttled</i>	<i>optimal flow</i>	<i>optimal pressure</i>	<i>max</i>
Q <sub>3</sub>	partially opened	above optimal flow	below optimal pressure	below max
Q <sub>max</sub>	fully opened	max	zero pressure	zero

Table 1 Evaluation of the system conditions

The following Figure 4 shows the relation between the Pump and turbine system curves:

- The performance of the turbine is higher compared with the pump performance (compare the 2 operation points)
- The turbine requires stable operation conditions (fixed flow-head)
- Variations in flow can be maintained with by-pass regulation
- Power cut from the grid requires special attention since the generator load drops to zero resulting in increase in speed, (n<sub>max</sub>=1.4 - 1.7 n 1/min)

- To avoid water hammer for the upstream transmission line, the following precaution can be applied:
  - Option 1: put on the brakes  $n=0$
  - Option 2: open a by-pass

The horizontal green line shows the change in flow according to the 2 presented options:

- Option 1: increase in flow (put on the brakes  $n=0$ )
- Option 2: reduction in flow (open a by-pass)

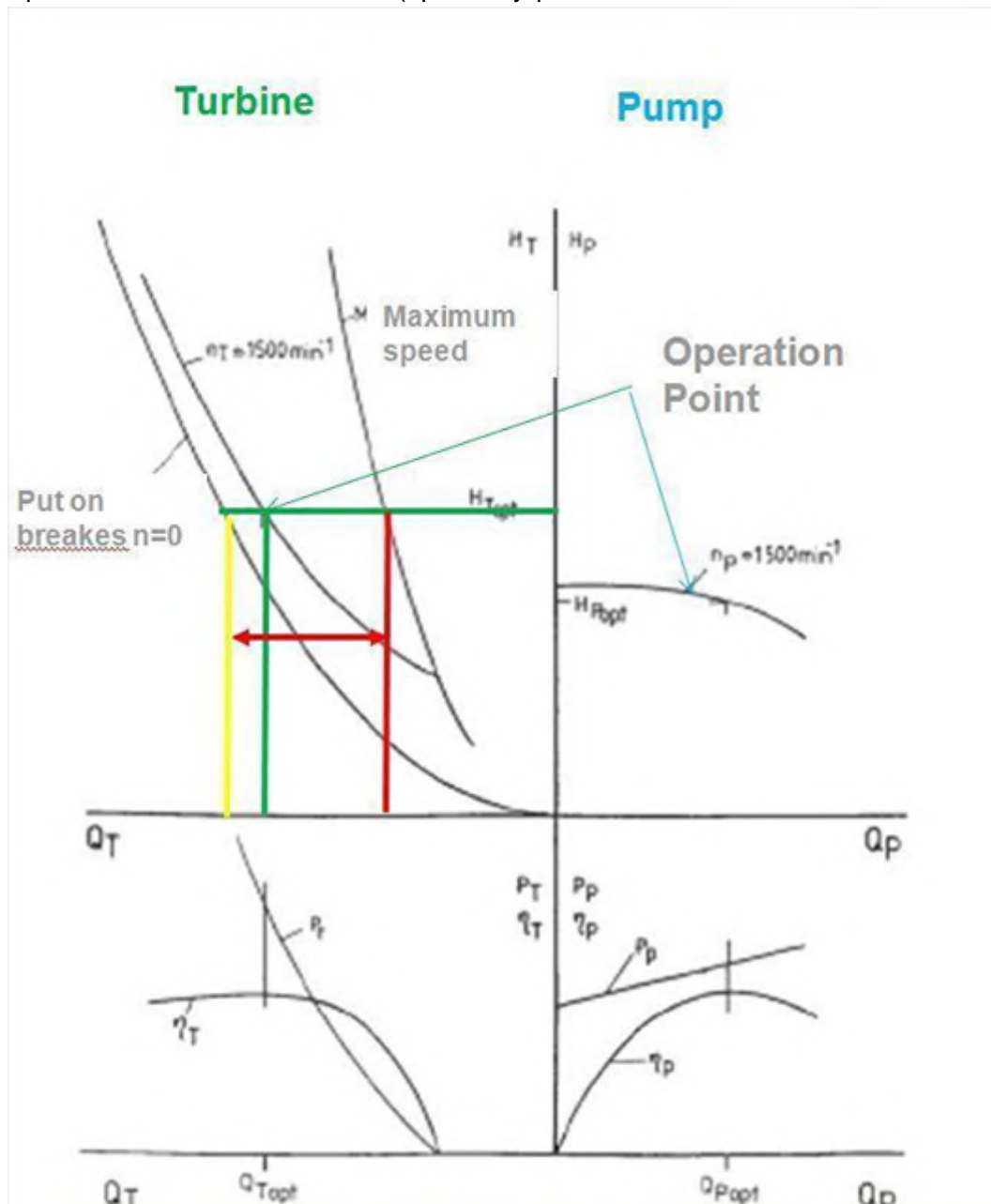

Figure 4 Specification of the operation point

Also frequency regulation can be applied for the application “pump as turbine” as indicated in the following Figure 5:

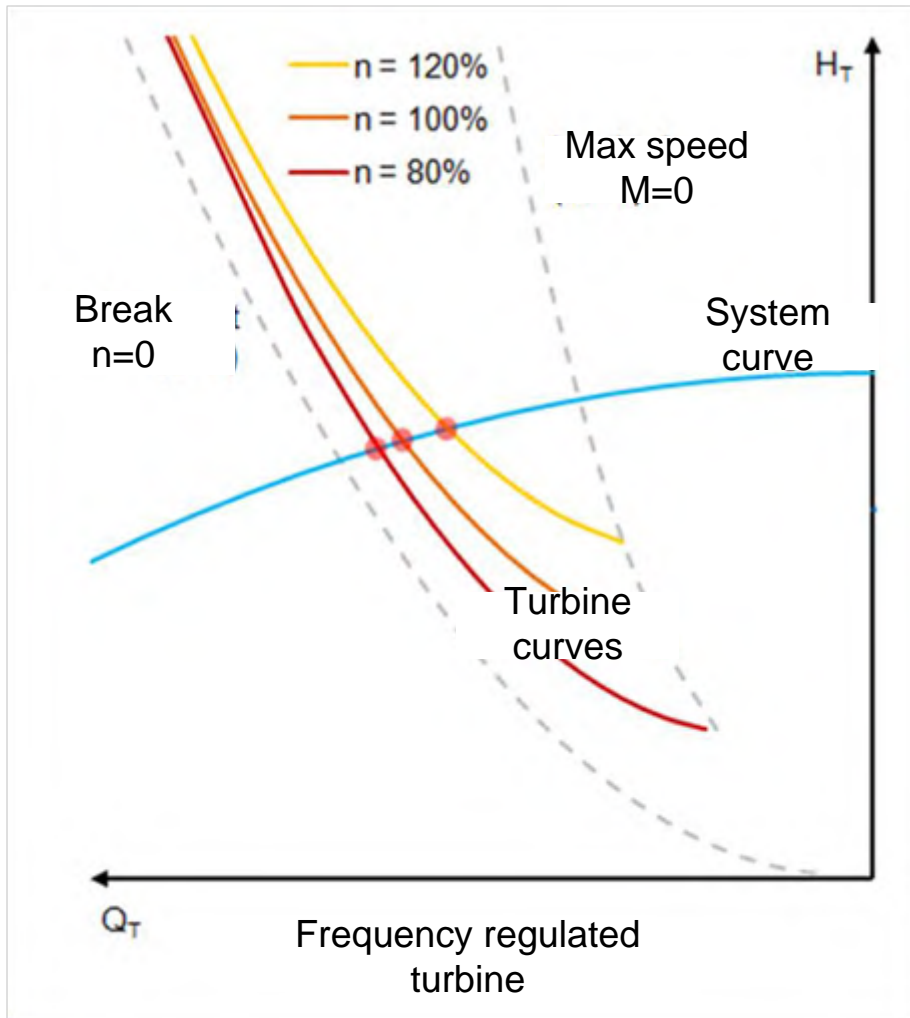

Figure 5 Frequency regulated turbine (80 to 120%)

#### Step 4 Evaluation of the Energy Generation Potential

In Figure 6 the formular for the calculation of the energy saving potential is displayed;

- **constant flow and pressure**

are the important system parameters in order to generate energy (P in kW).

For the calculation of the cost recovery the important parameters are

- energy cost which the utility will receive from the power company and
- the run time, how many hours the turbine is generating energy.

$$P = \frac{Q \cdot h \cdot \eta}{367}$$

$$Ce = P \cdot \text{run time} \cdot \text{charge rate}$$

Where:  $P$  = Power, kW  
 $Q$  = Flow rate, m<sup>3</sup>/h  
 $H$  = Head, m  
 $\eta_{total}$  = Total efficiency

Where:  $Ce$  = Energy costs, JD/kWh  
 $P$  = Power, kW  
 $\text{run time}$ , hours  
 $\text{charge rate}$ , JD / kWh

Figure 6 Calculation of the energy generation and cost recovery potential

### Step 5: General Technical Application

The following Figure 7 compares the basic concept using the pump as turbine:

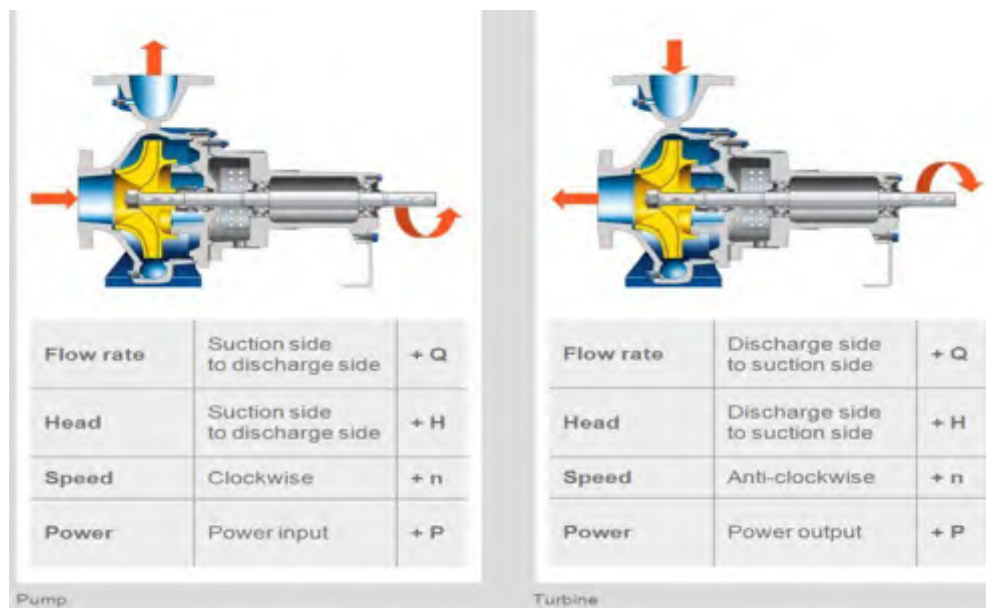

Figure 7 Basic concept of using pumps as turbines

According to the flow and head different pumps can be used as turbines:

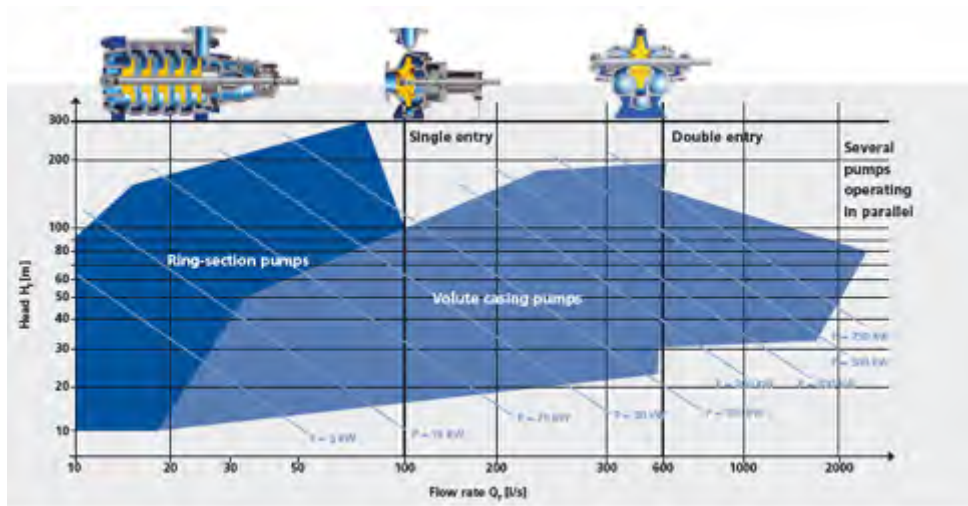

Figure 8 Selection of Pumps used as Turbines (examples from KSB catalogue)

- For low flow (20 to 80m<sup>3</sup>/h) and high head multiple stages pumps
- Medium flow and head single entry pumps
- High flow and medium head double flouted pumps

### Safety precautions for operations

In case of power cuts from the grid, the turbine would accelerate to high frequency and the flow will instantaneously decrease as it is shown in Figure 4 – green line).

A Hydraulic evaluation of the transmission system has to be undertaken to avoid water hammer in the upstream transmission line. The following Figure 9 shows possible safety precaution:

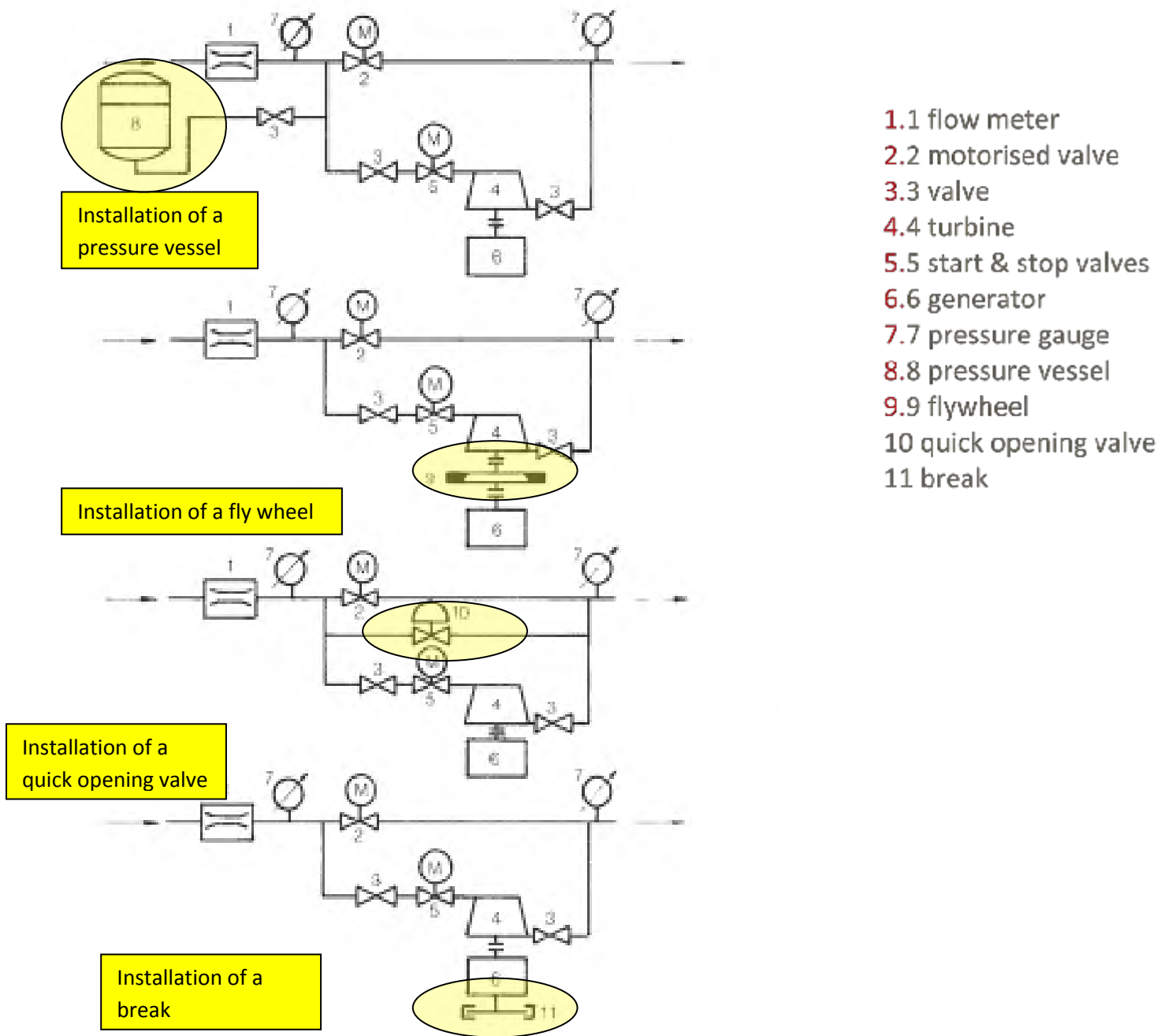

Figure 9 Regulations and precautions for the save operation

The flow of the system can be adjusted with the installation of turbines in parallel:

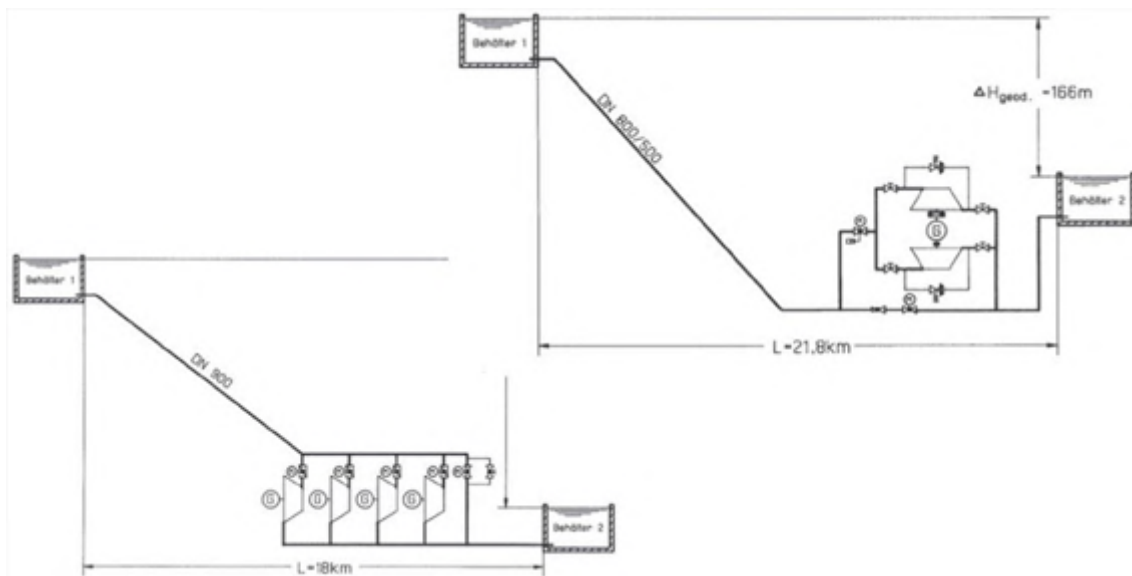

Figure 10 Regulation of the system with large variation in flow

## Step 6: Life Cycle Cost Calculation

The last step is to calculate if the investment for the installation of a turbine is cost effective.

In Table 2 the cost saving potential is calculated for an application with the following parameters (for more technical details see also the two systems in the attached chapter: Applications at Hamburg Water below).

- 10,000 m<sup>3</sup>/day and
- 5 bar excess pressure
- Total efficiency of turbine 70% (for a first step of the cost evaluation)
- Energy tariff 0.13 €/kW (figures from 2011 at HW)

Energy and Cost Saving potential									
	Flow			Pressure	Energy saving potential				Cost Saving
	m <sup>3</sup> /h	m <sup>3</sup> /day	m <sup>3</sup> /year		bar	hydraulic	usable (η=70%)		
				kWh/day		kW	kWh/day	kWh/year	EURO/year
Option 1	417	10,000	3,650,000	5	1,362	-40	-954	-348,093	<b>-45,252</b>

Table 2 Calculation of the cost saving potential

For this example an annual cost saving potential of 45,000 € was calculated. This energy is used to operate the main PS located at the neighbouring city Lübeck next to the turbine<sup>3</sup>.

The following Table 3 shows the input table for the **net present value method for the financial evaluation**; this method is applied at HW for the evaluation of investment projects:

<sup>3</sup> This turbine was planned in 2011 and installed in 2012.



- Estimated investment costs: 315,000 €
- Actual electricity tariff 0,13 €/kW (2012)
- Rate of interest: 1.048
- Life cycle for the installation: 10 years
- annual tariff increase (energy): 5%

Net Present Value Method					
Q = 417 m <sup>3</sup> /h					
1	Investment Costs	315,000 €			
2	actual tariff	0.13 €/kWh	5% annual tariff increase		
3	rate of interest	1.048			
4	life cycle	10 years		kW/a	Mill m <sup>3</sup> /a
5	hydraulic energy	1,362 kWh/d			
6	generated energy	-954 kWh/d	-348,093	3,650,000	-45,252

Table 3 Input table for the net present value method

The following table shows the output data from the net present value calculation:

- tariff forecast from 0,13 (2012) to 0,20 €/kW (2022)
- annual cost savings from 45,000 to 70,000 €/a
- 200 € annual maintenance costs, 1,000€ cost for general maintenance after 5 years
- The investment cost of 315,00€ are recovered after 6 years (red marked), in total about 248,000€ are recovered after 10 years of operation

NPV Calculation (€)							
Years	investment costs	tariff forecast	energy savings	maintenance	total	NPV	NPV accumulated
	(EURO)	(EURO/kW)	(EURO)				
1	315,000	0.13	-45,252	200	269,948	272,011	272,011
2		0.14	-47,515	200	-47,315	-47,315	224,697
3		0.14	-49,890	200	-49,690	-49,690	175,007
4		0.15	-52,385	200	-52,185	-52,185	122,822
5		0.16	-55,004	1,000	-54,004	-54,004	68,818
6		0.17	-57,754	300	-57,454	-57,454	11,364
7		0.17	-60,642	300	-60,342	-60,342	-48,978
8		0.18	-63,674	300	-63,374	-63,374	-112,352
9		0.19	-66,858	300	-66,558	-66,558	-178,910
10		0.20	-70,201	300	-69,901	-69,901	-248,810
	315,000		-569,175	3,300	-250,874		
					Cost recovery:	-248,810	

Table 4 Output table of the net present value method

The following figures shows the results of the net present value method also in a graphic:

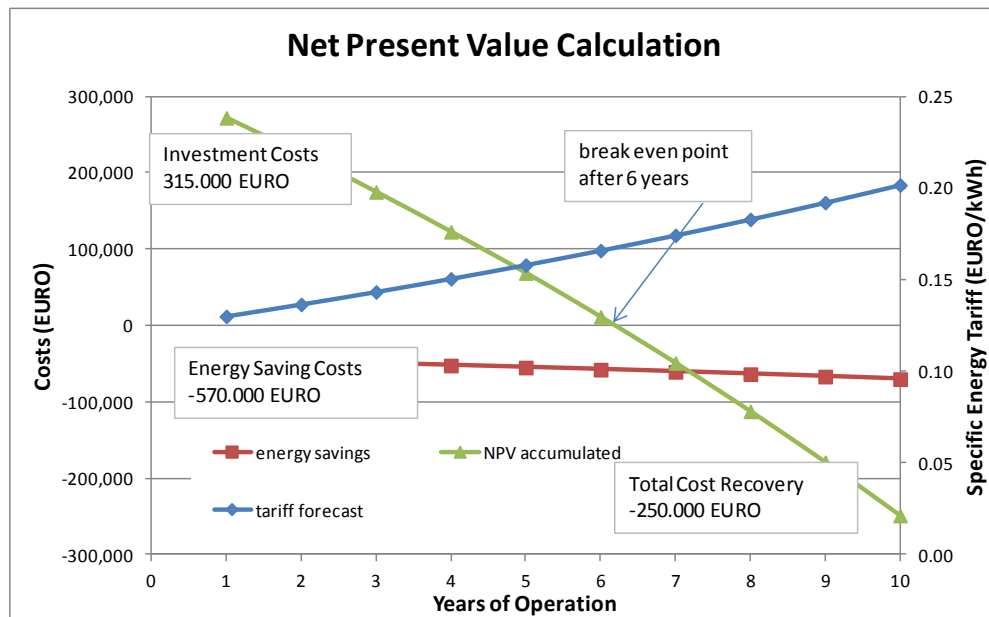

Figure 11 Output of the net present value method (graphic)

### Study Case Aquaba

As already explained Aquaba was selected as study case for the evaluation of the existing system in order to generate electricity.

Several studies were already undertaken and highlighting this potential to generate electricity. The following Figure 12 shows the details of the DISI line from DISI Reservoir to the High Terminal Reservoir (HTR) via 2 Pressure Break Tanks (PBT).

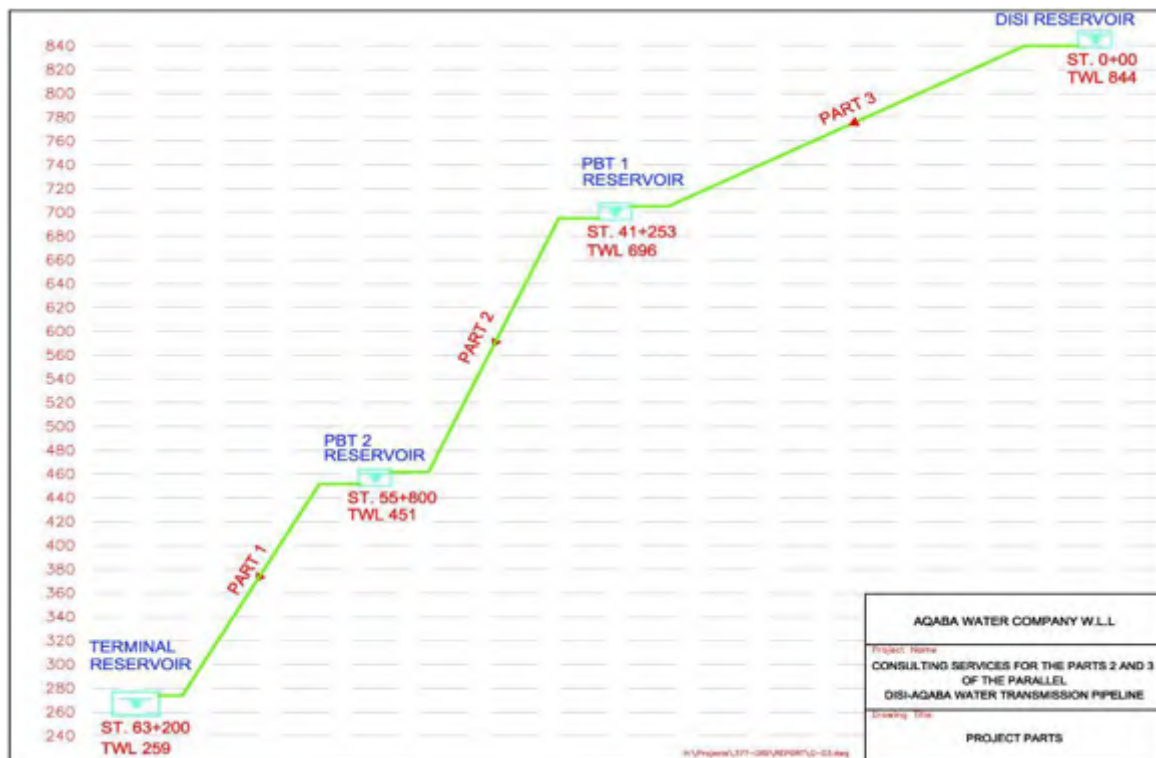

Figure 12 System Graphic of the DISI line

## Brief system description

1. The wells from DISI well field are pumping the raw water from the aquifer to the DISI reservoir (2,500m<sup>3</sup>) which is located at 844 masl. The raw water is clean and does not require any treatment except the chlorination.
2. The transmission system is equipped with
  - two PBT, (400 m<sup>3</sup>) located at 696 masl and 451 masl.
3. A HTR (3,000 m<sup>3</sup>) is collecting the water at the end of the transmission system at 259 masl.
4. The average flow is 1,900m<sup>3</sup>/h; the design flow is 2,600m<sup>3</sup>/h according to the information received from AWC. Due to this reduced flow an energy saving optional with turbines is expected; reference is made to Figure 1.



According to the initial explanations this flow of 1,900 m<sup>3</sup>/h is above the optimal flow ratio ( $1.900/2.600 = 0.73$ ) of 0.58; therefore the generated energy will be below the optimum, as explained in Figure 3. The optimum flow might be around 1,500 m<sup>3</sup>/h.

5. **In order to generate this energy potential 3 turbines have to be installed! An automated measuring and regulation system is required to achieve stable operation conditions.**

In order to verify this energy saving potential, the transmission line was inspected during the mission from 1<sup>th</sup> to 3<sup>rd</sup> of June. Due to the actual operation conditions no excess pressure could be measured:

- All pressure regulating valves at the entrance of the 1<sup>st</sup> & 2<sup>nd</sup> PBT and the HTR are fully open.
- But due to this operation conditions all reservoirs are empty and a mixture of air and water is sucked into the transmission system which creates additional pressure losses until stable hydraulic conditions are achieved. Therefore no excess pressure could be measured before the 2 PBT and the HTR.

Investigations undertaken during the mission:

- At the three positions before the 2 PBT and at the HTR manometers have been installed.
- In a first attempt the pressure regulation valve before the 2 PBTs and the HTR were throttled in order to get a first idea of the pressure potential.

## Required Measurement

1. AWC will execute a complete system test over 24 hours.
2. All 3 regulation valves before the two PBT and the HTR will be throttled until all 3 tanks are operated with stable conditions; the reservoirs will be adjusted with about 50% level (in order to avoid overflowing or sucking of air).
3. When stable conditions are achieved the following data will be recorded at all 3 locations:
  - pressure before the reservoirs (before the regulation valves)
  - flow measured at the DISI reservoir and the 2 connected booster stations (Rash PS)
  - Level of all 4 reservoirs

- Based on these data a brief evaluation of the energy and cost saving potential could be undertaken. The Energy saving potential could be calculated with the 3 excessive pressure potential measured, at the three locations and the average flow measured (about 1,900 m<sup>3</sup>/h):

$$P = \frac{(\Delta p1 + \Delta p2 + \Delta p3) * Q}{367 * 0,7} \text{ (kW)}$$

- The cost savings could be calculated with the energy generated over the whole year. The new energy price was received from WAJ, Project Management Unit with 0.11 JD/kW:

$$K = P * 24 * 365 * 0.11 \text{ (JD/a)}$$

### Measurements Undertaken

AWC has started to undertake some initial system measurements, due to the summer season with high water demand; the full required measurements could not be executed. The results of the measurements undertaken from the HTR will be further analysed in order to explain the selection of turbines for the energy generations:

The following Table 5 shows the flow – pressure measurements at the entrance of the HTR undertaken by throttling of the regulation valve at the entrance of the reservoir. These measurements should have been undertaken under the conditions that the 2<sup>nd</sup> PBT is filled, so that only water is in the transmission system!

HTR				
Pressure	Flow	Valve Position(%)	Power Production (kW)	Comments
8.6	1400	50	459	
6.1	1685	60	392	Corrected 6.8
5.4	2150	70	443	
3.7	2340	80	330	

**Table 5 Flow – Pressure measurements at the entrance of the HTR**

In the following Figure 13 the measurements are evaluated:

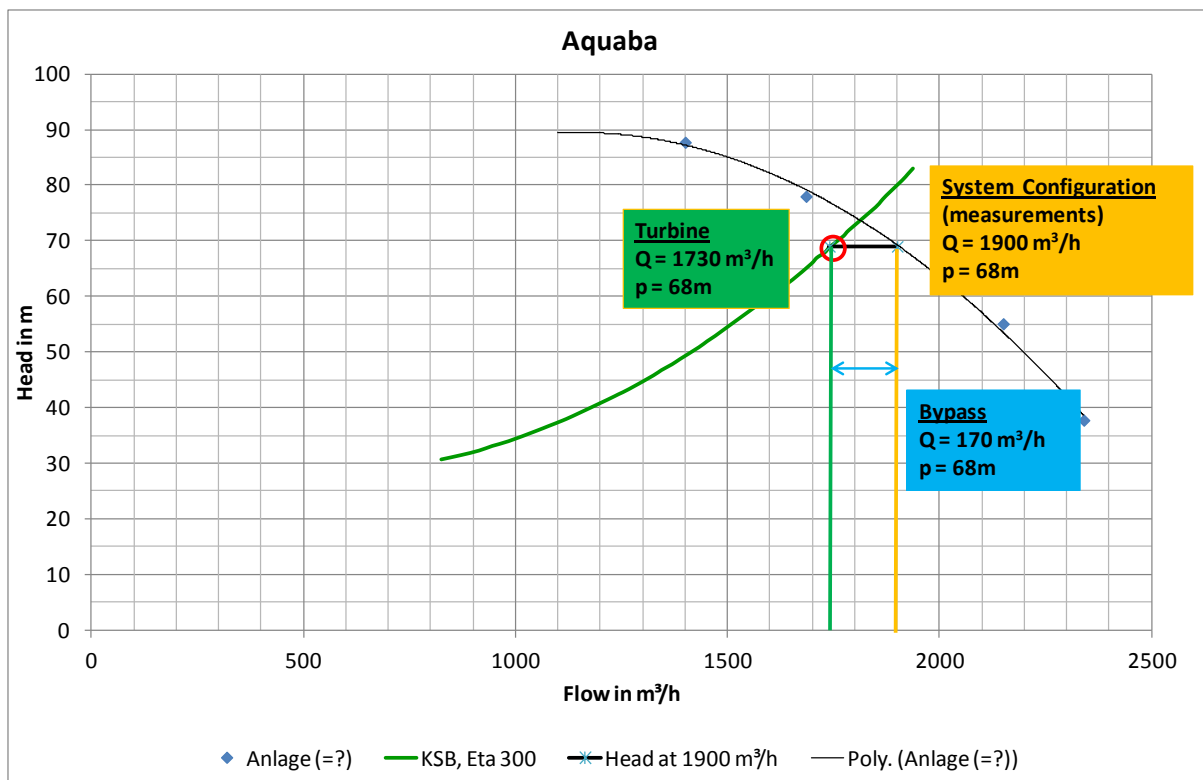

Figure 13 HTR: Evaluation of the Flow – Pressure measurements

Selection Criteria:

- Based on the information of the AWC management, that the required production for Aquaba is normally about 1,900m<sup>3</sup>/h, a remaining pressure of 68m can be used for energy generation. In order to specify a turbine, the manufacturer KSB was contacted to select a pump as turbine for this study case: the turbine ETA 300 was selected.
- Since the system curve and the curve of the turbine are matching in a fixed operation point (1730m<sup>3</sup>/h and 68m), the selection of the operation point showed be left of the system requirements (1,900 m<sup>3</sup>/h and 68m). The adjustment will be done by the regulation valve (170m<sup>3</sup>/h and 68m).

System Operation requirements:

- 1 1<sup>st</sup> regulation parameter: Level of the upper Reservoir  
 Since the flow through the turbine is regulated by the system pressure available before the turbine (see green line Figure 13) the total flow has to be adjusted by the main regulation valve in order to maintain the level of the upper reservoir. The total flow regulation has to be undertaken in order to keep the upper reservoir filled with water to avoid the intake of air into the transmission system.
- 2 2<sup>nd</sup> regulation parameter: synchronisation of the total flow for the 3 sub-systems  
 The transmission system from the well field to Aquaba is composed of 3 sub-systems:
  - 1<sup>st</sup> System: DISI reservoir transmission system & regulation valve (before 1<sup>st</sup> PBT)
  - 2<sup>nd</sup> System: 1<sup>st</sup> PBT, transmission system and regulation valve (before 2<sup>st</sup> PBT)
  - 3<sup>rd</sup> System: 2<sup>nd</sup> PBT, transmission system and regulation valve (before HTR)

- 3 Only if stable flow and also stable pressure conditions for the 3 sub-systems and therefore for the whole system can be achieved,
  - continuous water service conditions and also
  - stable energy generation can be maintained
  
- 4 SCADA Requirements for the regulations

All 4 reservoirs have to be equipped with level indicators: DICl reservoir, 1<sup>st</sup> & 2<sup>nd</sup> PBT and HTR

All 3 transmission lines have to be equipped with flow meters installed before the turbines: 1<sup>st</sup> & 2<sup>nd</sup> PBT and HTR

All 3 turbines have to have a local processing unit for automatic operation (start and stopping)

A data transmission system has to be installed to transmit the data from the 4 locations (DICl reservoir, 1<sup>st</sup> & 2<sup>nd</sup> PBT and HTR) to a central control system by:

  - *option 1*: a separate cable connection attached to the high tensions line or
  - *option 2*: the high tension lines could be used for data transmission
  
- 5 Energy generation potential!
  - flow specification for the turbines  $Q = 1,700\text{m}^3/\text{h}$
  - pressure for 1<sup>st</sup> PBT = 40m and
  - pressure for HTR = 68m
$$P = \frac{(40 + \Delta p_2 + 68) * Q * \eta}{367} \text{ (kW)} = 350 \text{ kW}$$

Annual cost saving potential: 370,000 JD (with 0.11 JD/kW)  
(The pressure potential of the 2<sup>nd</sup> PBT has to be measured and added)
  
- 6 Installation conditions

Very good installation conditions are available:

The high tension (11KV) power line goes along with the water transmission system, so the at all 3 locations the generated energy can be directly injected to the energy system and used for the DISI well field.

All 3 locations have 2 connections:

  - a direct connection to the reservoir with a regulation valve and
  - a second where the turbine can be installed (existing bypass).
  
- 7 The main entrance can be seen at the following Figure 14.

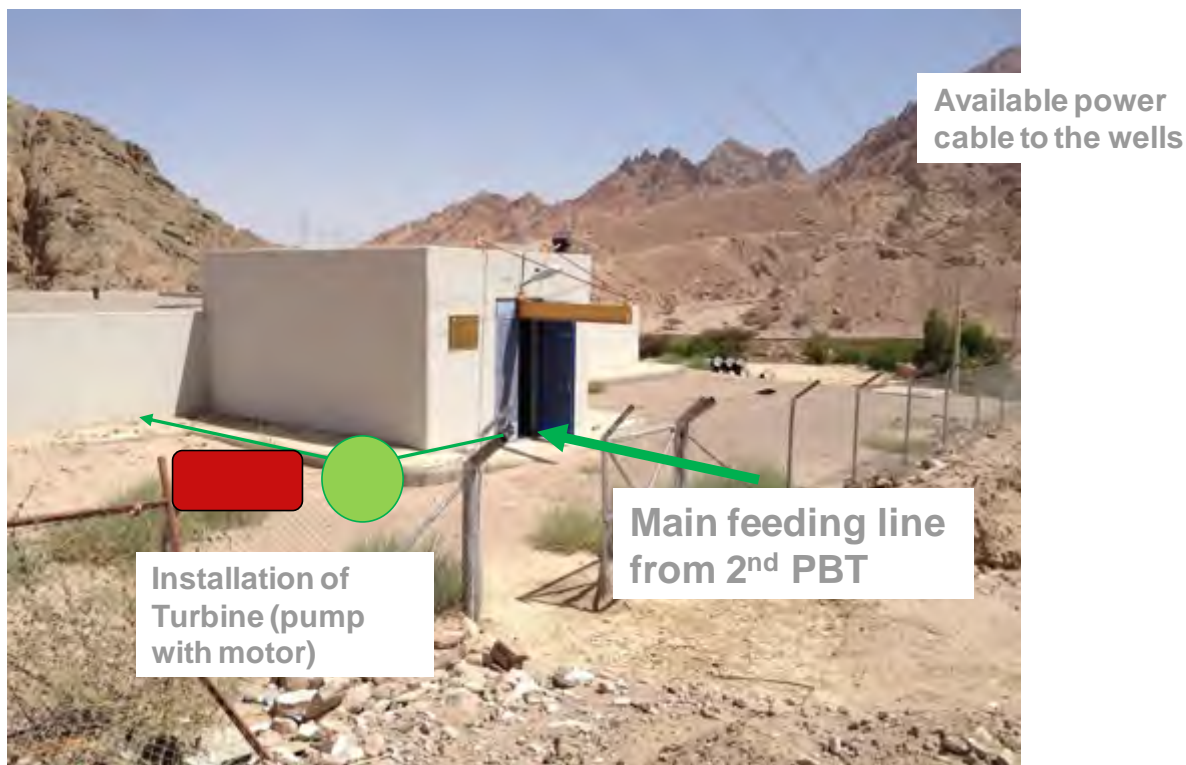

Figure 14 HTR with the proposed installation of the turbine

## Recommendations

1. The planning horizon of the project has to be estimated from AWC; a US financed project is under way to plan a new desalination plant for Elat (Israel) and Aquaba (Jordan) to supply drinking water from the Read See. It was indicated that the DICl water will be transmitted in future to the north of Jordan to supply Amman.
2. If the future water demand from DICl for Aquaba will increase the energy generation potential will tremendously decrease. The predicted demand figures have to be into consideration.
3. This short project study displays that the installation of 3 turbines in a cascaded system with 3 sub-systems in order to recover the remaining hydraulic energy potential is a complicated task.
4. It is recommended to complete the measurements with the assistance of the giz in order to estimate the actual energy saving potential. The existing measurements are not sufficient to expose reliable figures.
5. Finally a feasibility study is required to evaluate the
  - projected energy and cost saving potential against the
  - future investment costs for the installation (turbines and the SCADA system) inorder to estimate the pay back period.

## Applications at Hamburg Water

### Case 1 Water Work Stellingen

Application: Filling of the reservoir in the west of Hamburg during the night with excess water from the east of Hamburg

- pressure in the network 6 bar
- Flow 350 m<sup>3</sup>/h
- power generation 36 kW

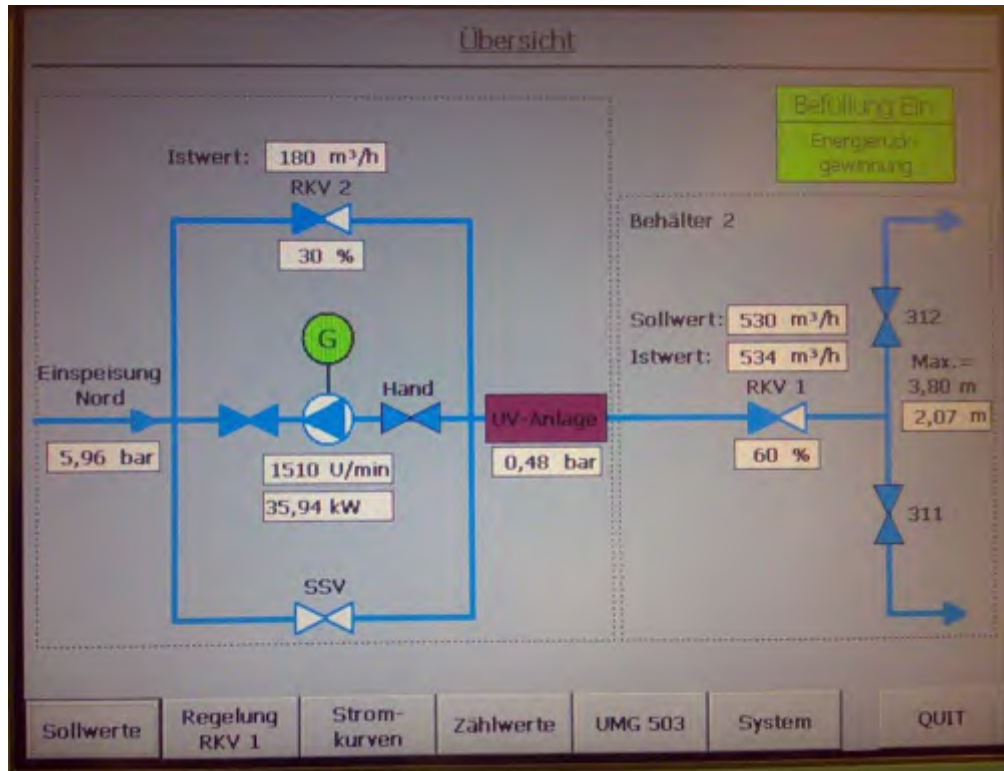

Figure 15 Task: Refilling of the reservoirs during the night from the network





Figure 16 WW Stellingen: Pump as Turbine

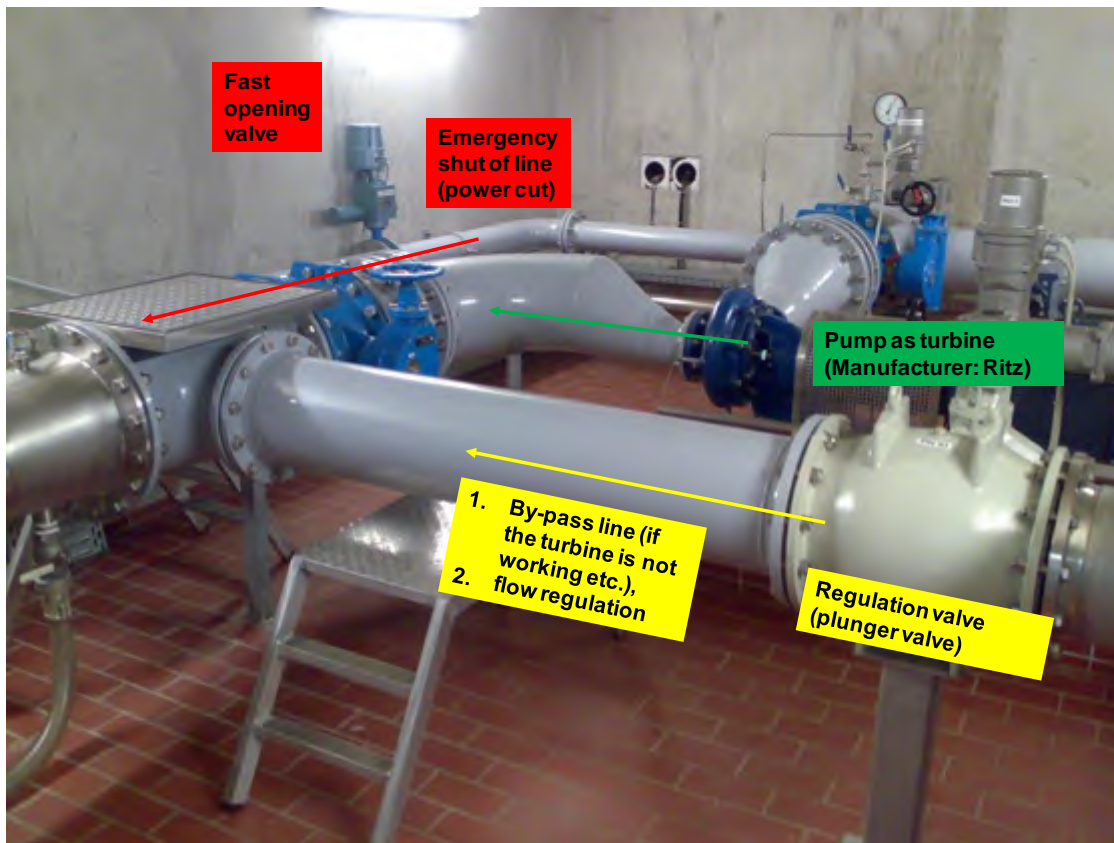

Figure 17 WW Stellingen: Pump as Turbine

## Case 2 Lübeck

Supply of drinking water from HW to the neighbouring City of Lübeck

- pressure in the network 4.2 bar
- Flow 480 m<sup>3</sup>/h
- power generation 30 kW

The following Figure 18 shows the process schema of the turbine stalled at Lübeck:

1. Direct feeding line (35) without turbine if the turbine is out of order (e.g. maintenance)
2. Turbine line (81)
3. Bypass line with pressure reducing valve (88) for flow regulations larger than  $Q_{max}$

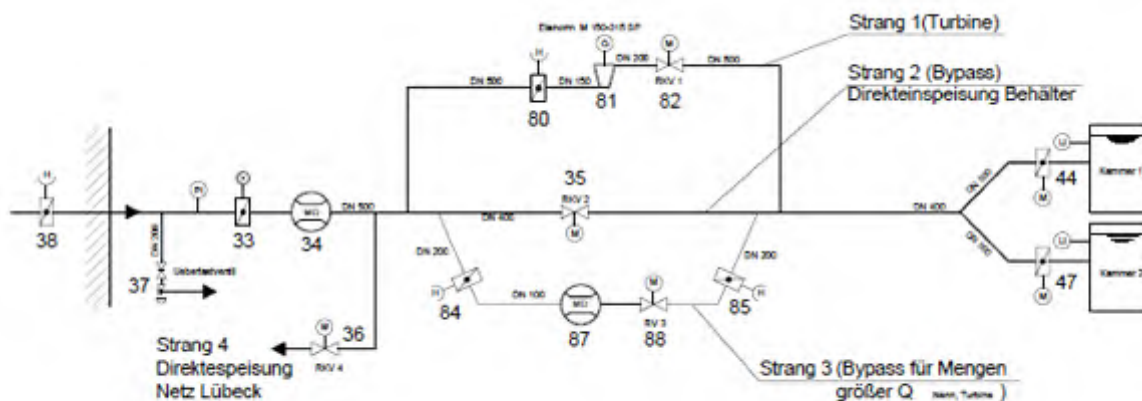

Figure 18 Process Schema of the Turbine Lübeck

The following Figure 19 shows the results of the hydraulic calculation in case of a power cut: the pressure does not exceed 7 bar for a pipeline of PN 10 therefore no quick opening valves was required.

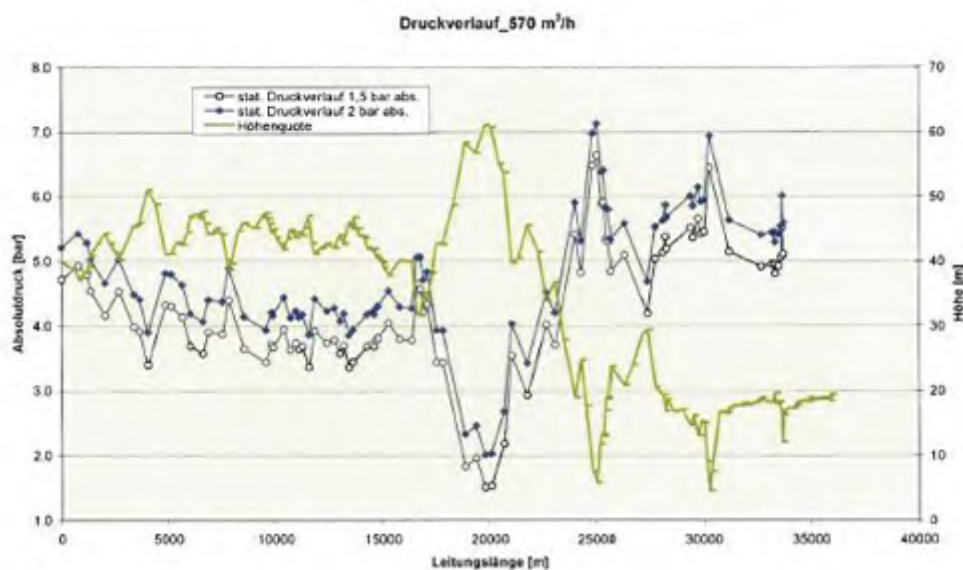

Figure 19 Hydraulic calculation in case of power cuts



السادة / الجمعية العربية لمرافق المياه ( أكو)

تحية طيبة وبعد،

أرجو إعلامكم بأن المصنف بطون " Guidelines Energy efficiency in Water and Wastewater Utilities"، تأليف: Arab Countries Water Utilities Association (ACWUA) قد تم منحه رقم إيداع في مركز الإيداع في دائرة المكتبة الوطنية تحت رقم الإيداع المبين أدناه.

يرجى العمل على تثبيت هذا الرقم كما هو مدون أدناه، في أي مكان ظاهر من المصنف، وتمثيلهم مركز الإيداع ثلاث نسخ على سبيل الإيداع وبحيث تكون النسخ المودعة مطابقة للمصنف من جميع الوجوه ومن أبعاد النسخ المنتجة، وذلك استناداً لأحكام المواد (38، 39، 40، 41) من قانون حماية حق المؤلف رقم (22) لسنة 1992 وتعديلاته، وأحكام نظام إيداع المصنفات رقم (4) لسنة 1994 م.

والقبول فائق الاحترام،،،،

The Hashemite Kingdom of Jordan  
The Deposit Number at The National Library  
(2016/4/1843)

يتحمل المؤلف كامل المسؤولية القانونية عن محتوى مصنفه ولا يجزأ هذا المصنف عن رأي دائرة المكتبة الوطنية أو أي جهة حكومية أخرى.

